

CATALOGUS

2017 . 2018

bouw- en meubelbeslag | garderobesystemen

Bau- und Möbelbeschläge | Garderoben

building and furniture fittings | cloakroom systems

éléments de construction et de meubles | vestiaires



Hermeta

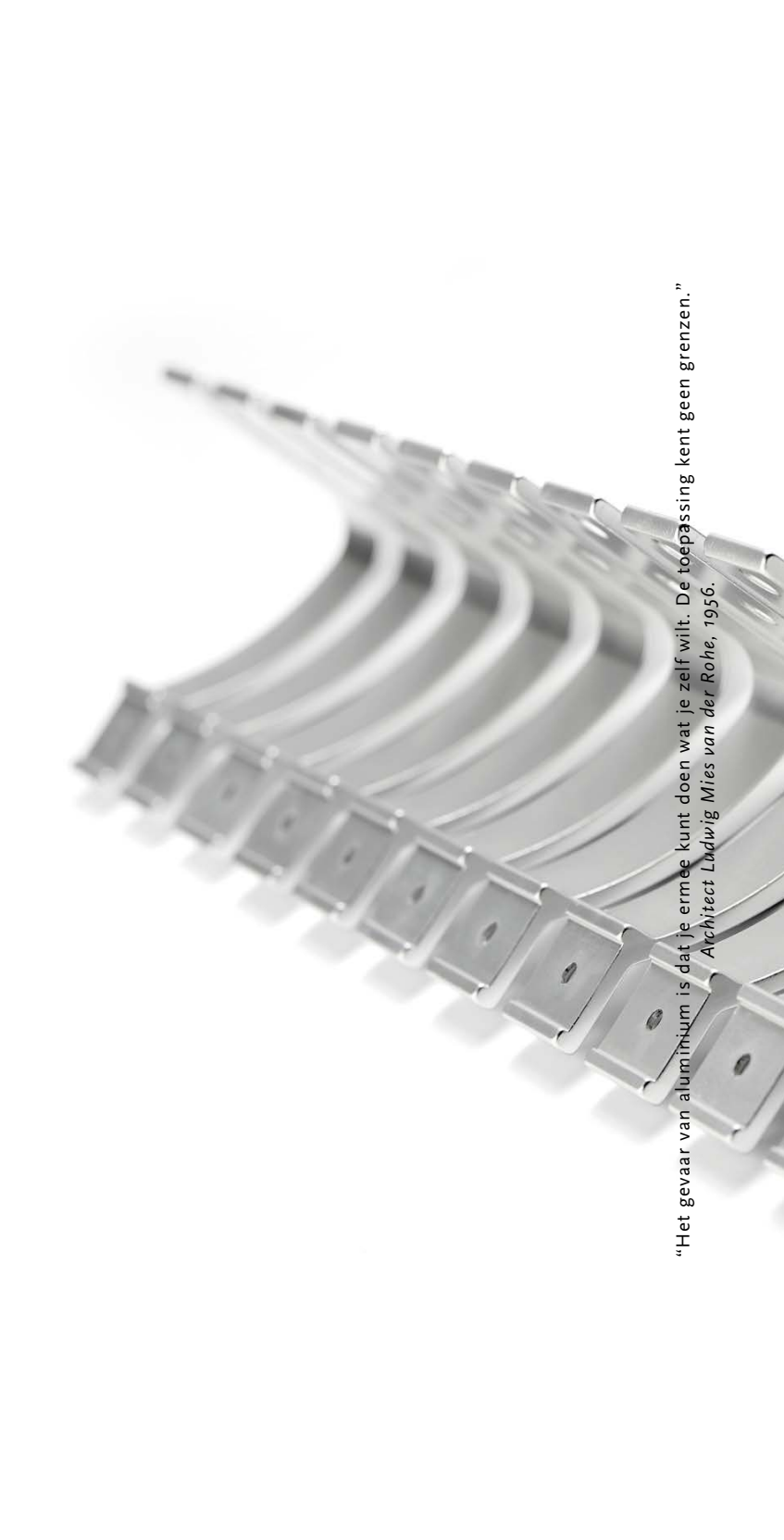

“Het gevaar van aluminium is dat je ermee kunt doen wat je zelf wilt. De toepassing kent geen grenzen.”
Architect Ludwig Mies van der Rohe, 1956.



KLEUREN | ARTIKELNUMMERS

KLEUREN De kleur van bouw- en meubelbeslag neemt een belangrijke plaats in bij het bepalen van de sfeer en de uitstraling van een interieur. Als fabrikant van aluminium bouw- en meubelbeslag anodiseren wij een groot aantal producten in diverse kleuren. Tevens wordt een aantal producten geëpoxeerd in diverse standaard RAL-kleuren. Veel artikelen kunnen op aanvraag eveneens in een door u gewenste kleur of uitvoering geleverd worden.

ARTIKELNUMMERS Met de eerste vier cijfers wordt het artikel gespecificeerd. Met de laatste twee cijfers wordt de kleur aangegeven.

ARTIKELNUMMER "F" De artikelnummers bestaan uit één letter, gevolgd door zeven cijfers. De laatste drie cijfers duiden de steekmaat in millimeters van de M4 gaten aan.

FARBEN | ARTIKELNUMMERN

FARBEN Die Farbe von Bau- und Möbelbeschlägen ist bei der Wahl der Atmosphäre und Ausstrahlung einer Inneneinrichtung besonders wichtig. Als Fabrikant von Bau- und Möbelbeschlägen aus Aluminium eloxieren wir eine Vielzahl von Produkten in verschiedenen Farben. Auf der anderen Seite werden auch viele Produkte in diversen Standard-Ral-Farben kunststoffbeschichtet. Viele Artikel können auf Anfrage auch in einer von Ihnen gewünschten Farbe oder Ausführung geliefert werden.

ARTIKELNUMMERN Mit den erste vier Ziffern wird der Artikel spezifiziert. Mit den letzten beiden Ziffern wird die Farbe angegeben.

BESTELLNUMMER "F" Die Artikelnummern bestehen aus einem Buchstabe mit nachfolgend sieben Zahlen. Die letzte drei Zahlen deuten den Abstand in Millimetern zwischen den M4 Löchern an.

COLOURS | ARTICLE NUMBERS

COLOURS The colour of builder's finish hardware and furniture fittings plays a major part in determining an interior's distinctive atmosphere and character. As manufacturer of aluminium finish hardware and furniture fittings, we anodise a large number of products in various colours. In addition, a number of products are epoxy plastic coated in various standard RAL colours. A lot of our articles can also be supplied, on request, in any colour or design of your choice.

ARTICLE NUMBERS The first four digits are used to specify the article. The last two digits indicate the colour.

PATTERN NUMBER "F" The article numbers contain one letter followed by seven digits. The last three digits specify the distance in millimeters between the M4 fixing holes.

COULEURS | NUMEROS D'ARTICLE

COULEURS La couleur des garnitures pour le bâtiment et le mobilier est un élément important pour définir l'ambiance et le rayonnement d'un intérieur. En tant que fabricant de garnitures en aluminium pour le bâtiment et le mobilier, nous anodisons un grand nombre de produits en différents coloris. Nous réalisons en outre un certain nombre de produits rilsanisé en différentes couleurs RAL standard. De nombreux articles peuvent également être livrés sur demande dans la couleur ou le modèle désirés.

NUMEROS D'ARTICLE Les quatre premiers chiffres permettent de spécifier l'article. Les deux derniers chiffres indiquent la couleur.

NO. d'ARTICLE "F" Les numéros d'articles existe par une lettre et sept chiffres. Les derniers trois chiffres indiquent la distance en millimètres entre les M4 trous taraudés.



Foto: Life Science Incubator, Universiteit Utrecht, i.s.m. Mecanoo

Aluminium kozijnen, ramen, deuren, balkonconstructies, gevelpanelen en vliesgevels. Met producten als deze staat Hermeta Gevelbouw voor maatwerk geveloplossingen in aluminium.

Hermeta Metaalwaren bv

postbus 1017,
4147 ZG Asperen
1e Industrieweg 1,
4147 CR Asperen Nederland

telefoon: +31 (0) 345 - 63 48 88

fax: +31 (0) 345 - 63 48 77

e-mail: metaalwaren@hermeta.nl

internet: www.hermeta.nl





Foto: Fort Resort Beemster, Zuidoostbeemster

Hermeta Projectbouw bv is gespecialiseerd in het ontwerpen, fabriceren en installeren van complete interieurs waaronder sanitaire cabines, lockers, garderobekasten, balies en nog veel meer.

Hermeta Metaalwaren bv is een onderdeel van de Hermeta Groep, waartoe ook Hermeta Projectbouw bv (sanitaire cabines en projectinrichting), Hermeta Gevelbouw bv (aluminium kozijnen en vliesgevels) en House of Hermeta Holland (design interieursieraden) behoren.

Als u geïnteresseerd bent in de activiteiten van de Hermeta Groep, kijk dan op onze website.



Hermeta Metaalwaren bv is één van de vier bedrijven die tezamen met Hermeta Gevelbouw bv, Hermeta Projectbouw bv en House of Hermeta Holland de Hermeta Groep vormen. De basis voor deze groep werd bijna 100 jaar geleden gelegd met de fabricage van bouw- en meubelbeslag. Alhoewel de vier bedrijven autonoom opereren maakt deze constructie het mogelijk om diensten en productietechnieken onderling te combineren en te versterken.

Door de unieke combinatie van gieten en profielverwerking heeft Hermeta in de loop der jaren een sterk assortiment met een geheel eigen karakter samengesteld. Het succesvolle samenspel van bijna 100 jaar ervaring en eigentijdse productiebeheersing is een waarborg voor kwaliteit. Het in 1993 behaalde ISO 9001 certificaat is hiervan een bevestiging. In deze catalogus vindt u een overzicht van het complete assortiment bouw- en meubelbeslag en garderobes van Hermeta. Het hele productieproces, te beginnen bij een eigen afdeling productontwikkeling, vindt plaats in haar eigen goed geoutilleerde bedrijf te Asperen. Een belangrijk deel van het assortiment wordt uit voorraad geleverd.

De indeling van deze catalogus maakt het mogelijk om snel en duidelijk uw keus te maken uit het totale assortiment. Door middel van foto's, illustraties en een compacte tekst worden de producten aan u gepresenteerd. Indien aanvullende informatie voor u van belang is, adviseren wij u contact op te nemen met onze verkoopmedewerkers die u graag te woord staan.

Asperen 2017
Hermeta Metaalwaren bv



Hermeta Metaalwaren bv ist eines der vier Unternehmen, die gemeinsam mit Hermeta Gevelbouw bv, Hermeta Projectbouw bv und House of Hermeta Holland die Hermeta Unternehmensgruppe bilden. Den Grundstein für diese Unternehmensgruppe wurde gegründet vor fast 100 Jahren mit der Herstellung von Bau- und Möbelbeschlägen. Obwohl die vier Unternehmen selbständig arbeiten, bietet diese Konstruktion die Möglichkeit, Dienstleistungen und Produktionstechniken miteinander zu kombinieren und zu verstärken.

Aufgrund der einzigartigen Verknüpfung von Gießen und Profilverarbeitung gelang es Hermeta, im Laufe der Jahre ein repräsentatives Sortiment mit einem völlig eigenen Charakter zusammenzustellen. Das erfolgreiche Zusammenspiel zwischen fast 100 jähriger Erfahrung und moderner Produktionsplanung bürgt für Qualität. Das im Jahre 1993 erworbene ISO 9001 Zertifikat bestätigt dies. In diesem Katalog finden Sie einen Überblick über das gesamte Sortiment an Bau- und Möbelbeschlägen und Garderoben von Hermeta. Der gesamte Produktionsprozeß, der in der eigenen Produktionsentwicklungsabteilung beginnt, findet im eigenen, gut ausgestatteten Unternehmen in Asperen statt. Ein wesentlicher Teil des Sortiments ist ab Lager lieferbar.

Der Katalog ist so eingeteilt, daß Sie Ihre Wahl rasch und bequem aus dem Gesamtsortiment treffen können. Anhand von Fotos, Illustrationen und einem kurzen Text werden die Produkte vorgestellt. Sollten Sie weitere Auskünfte benötigen, so empfehlen wir Ihnen, sich mit den Mitarbeitern unserer Verkaufsabteilung in Verbindung zu setzen, die gerne alle Ihre Fragen beantworten.

Asperen 2017
Hermeta Metaalwaren bv



Hermeta Metaalwaren bv is one of the four companies which, together with Hermeta Gevelbouw bv, Hermeta Projectbouw bv and House of Hermeta Holland, constitute the Hermeta Group. The basis for this group was formed almost 100 years ago by starting manufacturing building and furniture fittings. Although the four companies operate autonomously, this construction makes it possible to mutually combine and reinforce services and production techniques.

Due to the unique combination of casting and section processing, Hermeta has, over the years, put together a strong range with a completely unique character. The successful combination of almost 100 years of experience and modern production methods is a guarantee for quality. This is endorsed by the ISO 9001 certificate which was obtained in 1993.

This catalogue contains an overview of the complete range of Hermeta's building and furniture fittings and wardrobes. The entire production process, starting with the company's own product development department, takes place at the company's own well-equipped premises in Asperen. A significant part of the range can be supplied from stock. This catalogue has been arranged so that you can make your selection from the total range quickly and easily. The products are presented to you by means of photos, illustrations and succinct descriptions. If you would like any additional information, we recommend that you contact one of our sales staff, who will be only too pleased to assist.

Asperen 2017
Hermeta Metaalwaren bv



Hermeta Metaalwaren bv est l'une des quatre entreprises qui avec Hermeta Gevelbouw bv, Hermeta Projectbouw bv et House of Hermeta Holland forme le Groupe Hermeta. Les bases de ce groupe ont été jetées il y a près de 100 ans avec fabriquer des garnitures pour le bâtiment et le mobilier. Les quatre entreprises opèrent de façon autonome, mais elles sont soutenues par cette construction qui permet de combiner et de mettre à profit les techniques de production et les services.

La combinaison unique des activités de moulage et de profilage a permis à Hermeta de composer au cours des années un vaste assortiment de produits tout à fait originaux. La conjonction fructueuse de près de 100 ans d'expérience et d'un équipement de production ultramoderne est une garantie de qualité. Le certificat ISO 9001 obtenu en 1993 est la preuve. Ce catalogue vous offre un aperçu de l'assortiment complet d'Hermeta en matière de portemanteaux et de garnitures pour le bâtiment et le mobilier. L'ensemble du processus de fabrication, à commencer par la conception de produits, est réalisé dans notre propre usine, parfaitement outillée, à Asperen. Une partie importante de l'assortiment est livré de stock.

Ce catalogue a été conçu de façon à faciliter votre choix en vous offrant une vue d'ensemble précise de tout notre assortiment. Les produits vous sont présentés au moyen de photos et d'illustrations accompagnant un texte concis. Pour toute information complémentaire importante pour vous, nous vous conseillons de prendre contact avec nos collaborateurs du service des ventes, qui vous renseigneront volontiers.

Asperen 2017
Hermeta Metaalwaren bv



HOOFDSTUK 1	HAKEN EN KAPSTOKGARNITUREN		
	- Hoed- en Jashaken	12 t/m 25	
	- Handdoekhaken	26 t/m 28	
	- Handdoekrekjes	29 t/m 31	
	- Kastroedebuis	32	
	- Schuifhaken	33	
	- Kapstokgarnituren	34 t/m 39	
	- Wandgarderobe	40 en 41	
	- Kapstok	42 en 43	
HOOFDSTUK 2	LEUNINGHOUDERS EN WANDLEUNING		
	- Leuninghouders, gegoten	46 t/m 49	
	- Leuninghouders, profiel	50 t/m 53	
	- Afstandhouders	54 en 55	
	- Samengestelde leuninghouders	56 en 57	
	- Onderdelen voor samengestelde leuninghouders	58 t/m 63	
	- Wandleuningsysteem	64 en 65	
HOOFDSTUK 3	GREPEN, MEUBELKNOPPEN, DEURDUWERS EN DEURBUFFERS		
	- Meubelgrepen	68 t/m 87	
	- Meubelknoppen	88 t/m 97	
	- Ladegrepen	98 en 99	
	- Handgrepen, profiel	100 t/m 102	
	- Handgrepen, gegoten	103 t/m 105	
	- Raamlichters en raampennen	106	
	- Schuifdeurkommen	107 t/m 109	
	- Deurduwers	110 t/m 114	
	- Deurbuffers	115 t/m 117	
HOOFDSTUK 4	WANDRAILSYSTEEM EN DRAGERS		
	- Wandrailsysteem METALUX	120 t/m 123	
	- Bevestigingshoek	124	
	- Universele console	125	
HOOFDSTUK 5	WANDASBAKKEN EN AFVALBAKKEN		
	- Wandasbakken	128	
	- Afvalbakken	130 en 131	
HOOFDSTUK 6	DOORVALBEVEILIGING EN DIVERSEN		
	- Doorvalbeveiligingsbuis	135	
	- Doorvalbeveiligingssteunen	135	
	- Koordhouders	138	
	- Afsluitblokjes	139	
	- Stelvoeten	140	
	- Dopmoeren	141	
	- Draadeinden, stokschroeven en inbusbout	142	
HOOFDSTUK 7	GARDEROBES		
	- GARDELUX 1	Garderoberos Losse onderdelen	148 t/m 157 158 t/m 170
	- GARDELUX 2	Garderoberos Losse onderdelen	172 t/m 180 181 t/m 191
	- GARDELUX ALLURE	Garderoberos	192 t/m 197
	- GARDELUX DOCK	Garderoberos	198 t/m 201
HOOFDSTUK 8	ZITBANKEN		
	- Zitbanken	204 t/m 207	
	- Losse onderdelen	208 t/m 211	
HOOFDSTUK 9	GARDEROBEFRAMES, KAPSTOKKEN, JASSENREK, PARAPLUSTANDAARDS, URINOIRSCHOT		
	- Garderobeframes	214 t/m 216	
	- Staande kapstokken	217 t/m 219	
	- Jassenrek	220	
	- Paraplustandaards	221 t/m 225	
	- Urinoirschot	226	



GRUPPE 1	HAKEN UND GARDEROBENLEISTEN		
	- Hut- und Mantelhaken	12 bis 25	
	- Handtuchhaken	26 bis 28	
	- Handtuchleisten	29 bis 31	
	- Schrankrohre	32	
	- Schiebehaken	33	
	- Garderobenleisten	34 bis 39	
	- Wandgarderobe	40 und 41	
	- Hakenleiste	42 und 43	
GRUPPE 2	HANDLAUFSTÜTZEN UND HANDLÄUFE		
	- Handlaufstützen, gegossen	46 bis 49	
	- Handlaufstützen, profil	50 bis 53	
	- Abstandhalter	54 und 55	
	- Handlaufstützen, zusammengesetzt	56 und 57	
	- Einzelteile für Handlaufstützen	58 bis 63	
	- Handlaufsystem	64 und 65	
GRUPPE 3	GRIFFE, MÖBELKNÖPFE, TÜRGRIFFE UND TÜRPUFFER		
	- Möbelgriffe	68 bis 87	
	- Möbelknöpfe	88 bis 97	
	- Ladegriffe	98 und 99	
	- Griffe, profil	100 bis 102	
	- Griffe, gegossen	103 bis 105	
	- Fenstergriffe und Fenstersicherung	106	
	- Muschelgriffe	107 bis 109	
	- Türgriffe	110 bis 114	
	- Türpuffer	115 bis 117	
GRUPPE 4	WANDSCHIENE SYSTEM UND TRÄGER		
	- Wandschiene System METALUX	120 bis 123	
	- Montagewinkel	124	
	- Universalkonsole	125	
GRUPPE 5	WANDASCHER UND ABFALLBEHÄLTER		
	- Wandascher	128	
	- Abfallbehälter	130 und 131	
GRUPPE 6	VERSCHIEDENES		
	- Rohr zur absturzsicherung	135	
	- Träger für absturzsicherung	135	
	- Schnurhalter	138	
	- Abdeckkappen mit Gewindeloch	139	
	- Stellfüsse	140	
	- Hutmutter	141	
	- Gewindestangen, Stockschrauben, Zylinderschraube	142	
GRUPPE 7	GARDEROBEN		
	- GARDELUX 1	Garderoben	148 bis 157
		Lose Teile	158 bis 170
	- GARDELUX 2	Garderoben	172 bis 180
		Lose Teile	181 bis 191
	- GARDELUX ALLURE	Garderoben	192 bis 197
	- GARDELUX DOCK	Garderoben	198 bis 201
GRUPPE 8	SITZBÄNKE		
	- Sitzbänke	204 bis 207	
	- Lose Teile	208 bis 211	
GRUPPE 9	RAHMEN FÜR GARDEROBEN, GARDEROBENSTÄNDER KLEIDERSTÄNDER, SCHIRMSTÄNDER, URINALTRENNWAND		
	- Rahmen für Garderoben	214 bis 216	
	- Garderobenständer	217 bis 219	
	- Kleiderständer	220	
	- Schirmständer	221 bis 225	
	- Urinaltrennwand	226	



SECTION 1	HOOKS AND COAT RACKS	
	- Hat and coat hooks	12 - 25
	- Towel hooks	26 - 28
	- Towel hooks and rails	29 - 31
	- Cupboard tube	32
	- Sliding hooks	33
	- Coat racks	34 - 39
	- Coat rack system	40 - 41
	- Coat hook strip	42 - 43
SECTION 2	HANDRAIL BRACKETS AND HANDRAILS	
	- Handrail brackets, cast	46 - 49
	- Handrail brackets, extruded	50 - 53
	- Handrail brackets, spacer	54 - 55
	- Handrail brackets, composed	56 - 57
	- Parts for handrail brackets, composed	58 - 63
	- Handrail system	64 - 65
SECTION 3	PULL HANDLES, CUPBOARD KNOBS, PUSH PADS AND DOOR CHECKS	
	- Cabinet handles	68 - 87
	- Cupboard knobs	88 - 97
	- Cupboard handles	98 - 99
	- Handles, extruded	100 - 102
	- Handles, cast	103 - 105
	- Window handles and sash pins	106
	- Flush pull	107 - 109
	- Push pads	110 - 114
	- Door checks	115 - 117
SECTION 4	WALL MOUNTING RAIL SYSTEM AND BRACKETS	
	- Wall mounting rail system METALUX	120 - 123
	- Corner clasps	124
	- Brackets universal	125
SECTION 5	WALL MOUNTING ASHTRAYS AND WASTE BINS	
	- Wall mounting ashtrays	128
	- Waste bins	130 - 131
SECTION 6	MISCELLANEOUS	
	- Tubes for fall prevention	135
	- Brackets for fall protection	135
	- Cleat hooks	138
	- Threaded ends	139
	- Adjustable feet	140
	- Dome headed nuts	141
	- Threaded rods and screws	142
SECTION 7	CLOAKROOM SYSTEMS	
	- GARDELUX 1	Hat and coat racks 148 - 157
		Loose parts 158 - 170
	- GARDELUX 2	Hat and coat racks 172 - 180
		Loose parts 181 - 191
	- GARDELUX ALLURE	Hat and coat racks 192 - 197
	- GARDELUX DOCK	Hat and coat racks 198 - 201
SECTION 8	BENCHES	
	- Benches	204 - 207
	- Loose parts	208 - 211
SECTION 9	FRAMES, COAT STANDS, COAT RACKS, UMBRELLA STANDS, URINAL PARTITION	
	- Frames	214 - 216
	- Coat stands	217 - 219
	- Coat rack	220
	- Umbrella stands	221 - 225
	- Urinal partition	226



SECTION 1	CROCHETS ET PORTE-MANTEAUX	
	- Crochets porte-chapeau et porte-manteau	12 à 25
	- Crochets essuie-main	26 à 28
	- Porte-serviettes	29 à 31
	- Tubes d'armoire	32
	- Crochets glissant	33
	- Porte-manteaux, système	34 à 39
	- Porte-manteaux, bande	40 à 41
	- Porte-manteaux	42 à 43
SECTION 2	SUPPORTS DE MAIN COURANTE ET MAIN COURANTE	
	- Supports de main courante, en fonte d'aluminium	46 à 49
	- Supports de main courante, en profilé d'aluminium	50 à 53
	- Supports de main courante, spacer	54 à 55
	- Supports de main courante, composé	56 à 57
	- Accessoires pour supports de main courante, composé	58 à 63
	- Système de main courante	64 à 65
SECTION 3	POIGNEES, BOUTONS DE MEUBLE, POIGNEES DE PORTE ET ARRÊTS DE PORTE	
	- Poignées de porte	67
	- Poignées de meuble	68 à 87
	- Boutons de meuble	88 à 97
	- Poignées de tiroir	98 à 99
	- Poignées, en profilé d'aluminium	100 à 102
	- Poignées, en fonte d'aluminium	103 à 105
	- Poignées de fenêtre et goupilles	106
	- Poignée cuvette pour porte coulissante	107 à 109
	- Poignées de porte	110 à 114
	- Arrêts de porte	115 à 117
SECTION 4	SYSTÈME CRÉMAILLÈRE MURALE ET SUPPORTS	
	- Système METALUX	120 à 123
	- Equerre d'assemblage	124
	- Console	125
SECTION 5	CENDRIERS ET POUBELLES À FIXER SUR PAROI	
	- Cendriers	128
	- Poubelles	130 à 131
SECTION 6	QUINCAILLERIE DIVERS	
	- Barre de protection	135
	- Supports pour barre de protection	135
	- Taquets	138
	- Embouts taraudés	139
	- Pieds réglables	140
	- Ecrous borgnes	141
	- Tiges filetées et vis captives	142
SECTION 7	VESTIAIRES	
	- GARDELUX 1	Vestiaires 148 à 157
		Pièces détachées 158 à 170
	- GARDELUX 2	Vestiaires 172 à 180
		Pièces détachées 181 à 191
	- GARDELUX ALLURE	Vestiaires 192 à 197
	- GARDELUX DOCK	Vestiaires 198 à 201
SECTION 8	BANCS	
	- Bancs	204 à 207
	- Pièces détachées	208 à 211
SECTION 9	CADRES DE VESTIAIRE, PORTE-MANTEAUX À PIED, PORTE-MANTEAUX, PORTE-PARAPLUIES, PARTITION URINOIR	
	- Cadres de vestiaire	214 à 216
	- Porte-manteaux à pied	217 à 219
	- Porte-manteaux	220
	- Porte-parapluies	221 à 225
	- Partition urinoir	226



12

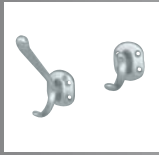

13

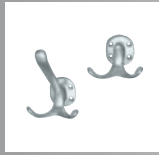

14



15



16



17



18



19



20



21



22

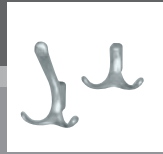

23



24



25



26



27



28



29



30



31

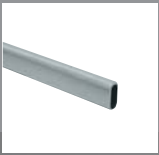

32



33

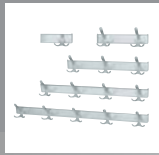

34...38



39



40

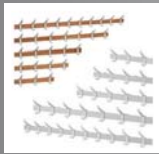

41

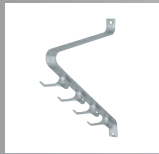

42



43



HAKEN EN
KAPSTOKGARNITUREN

HAKEN UND
GARDEROBENLEISTEN

HOOKS AND
COAT RACKS

CROCHETS ET
PORTE-MANTEAUX

HOED- EN JASHAKEN

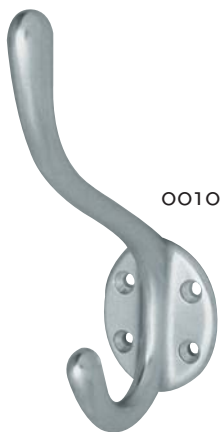

OO10



OO11

HOED- en JASHAKEN gegoten aluminium, geanodiseerd	HUT- und MANTEL- HAKEN Leichtmetall, eloxiert	HAT and COAT HOOKS cast aluminium, anodized	CROCHETS PORTE- CHAPEAU et PORTE- MANTEAU en fonte d'aluminium, anodisé
-01 naturel -02 nieuwzilver	-01 silber -02 neusilber	-01 silver -02 continental	-01 argent -02 champagne

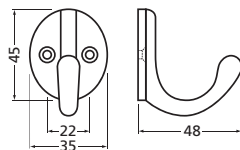
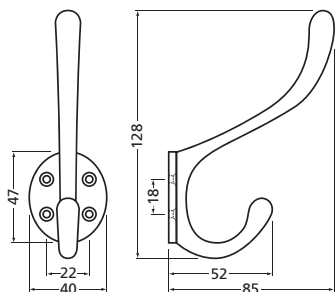

HOED- EN JASHAKEN



0026



0027

HOED- en JASHAKEN gegoten aluminium, geanodiseerd	HUT- und MANTEL- HAKEN Leichtmetall, eloxiert	HAT and COAT HOOKS cast aluminium, anodized	CROCHETS PORTE- CHAPEAU et PORTE- MANTEAU en fonte d'aluminium, anodisé
-01 naturel -02 nieuwzilver	-01 silber -02 neusilber	-01 silver -02 continental	-01 argent -02 champagne

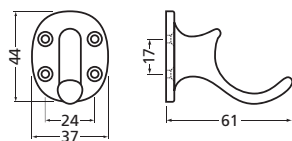
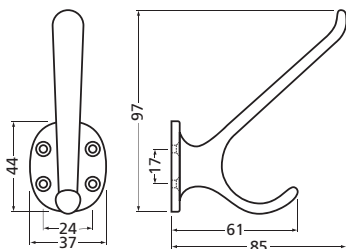

HOED- EN JASHAKEN



HOED- en JASHAKEN gegoten aluminium, geanodiseerd	HUT- und MANTEL- HAKEN Leichtmetall, eloxiert	HAT and COAT HOOKS cast aluminium, anodized	CROCHETS PORTE- CHAPEAU et PORTE- MANTEAU en fonte d'aluminium, anodisé
-01 naturel -02 nieuwzilver	-01 silber -02 neusilber	-01 silver -02 continental	-01 argent -02 champagne

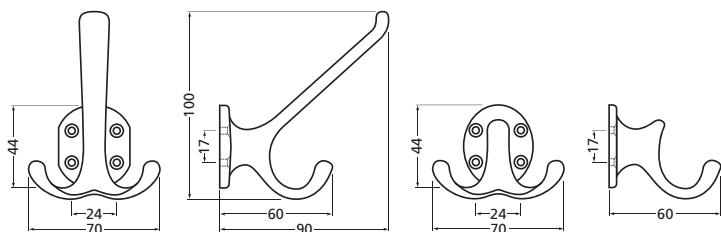

HOED- EN JASHAKEN



0030



0031

HOED- en JASHAKEN gegoten aluminium	HUT- und MANTEL- HAKEN Leichtmetall	HAT and COAT HOOKS cast aluminium	CROCHETS PORTE- CHAPEAU et PORTE- MANTEAU en fonte d'aluminium
geanodiseerd -01 naturel -02 nieuwzilver	eloxiert -01 silber -02 neusilber	anodized -01 silver -02 continental	anodisé -01 argent -02 champagne
geëpoxeerd -70 zwart	kunststofbeschildet -70 schwarz	epoxy plastic coated -70 black	riksanisé -70 noir

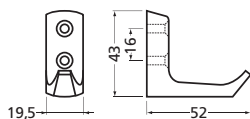
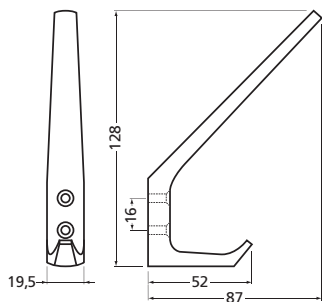

HOED- EN JASHAKEN



0032



0033

HOED- en JASHAKEN gegoten aluminium	HUT- und MANTEL- HAKEN Leichtmetall	HAT and COAT HOOKS cast aluminium	CROCHETS PORTE- CHAPEAU et PORTE- MANTEAU en fonte d'aluminium
geanodiseerd -01 naturel -02 nieuwzilver	eloxiert -01 silber -02 neusilber	anodized -01 silver -02 continental	anodisé -01 argent -02 champagne
geëpoxeerd -70 zwart	kunststofbeschildet -70 schwarz	epoxy plastic coated -70 black	riksanisé -70 noir

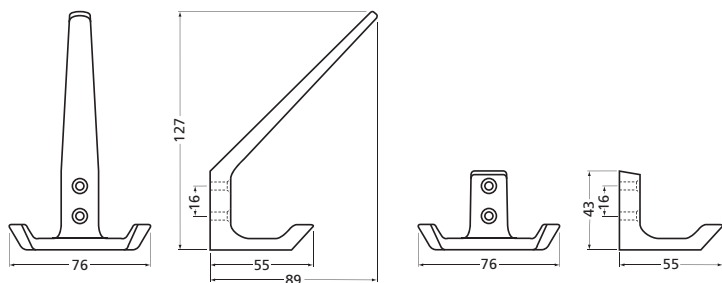

HOED- EN JASHAKEN



0034



0035

HOED- en JASHAKEN gegoten aluminium, geanodiseerd	HUT- und MANTEL- HAKEN Leichtmetall, eloxiert	HAT and COAT HOOKS cast aluminium, anodized	CROCHETS PORTE- CHAPEAU et PORTE- MANTEAU en fonte d'aluminium, anodisé
-01 naturel -02 nieuwzilver	-01 silber -02 neusilber	-01 silver -02 continental	-01 argent -02 champagne

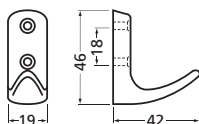
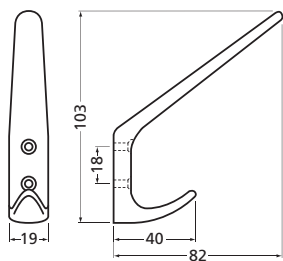

HOED- EN JASHAKEN



0138



0139

HOED- en JASHAKEN van aluminium profiel	HUT- und MANTEL- HAKEN Leichtmetall	HAT and COAT HOOKS extruded aluminium	CROCHETS PORTE- CHAPEAU et PORTE- MANTEAU en profilé d'aluminium
geanodiseerd -01 naturel -02 nieuwzilver -11 mat naturel	eloxiert -01 silber -02 neusilber -11 matt silber	anodized -01 silver -02 continental -11 matt silver	anodisé -01 argent -02 champagne -11 argent mat
geëpoxeerd -70 zwart -79 wit	kunststoffbeschichtet -70 schwarz -79 weiss	epoxy plastic coated -70 black -79 white	rilsanisé -70 noir -79 blanc

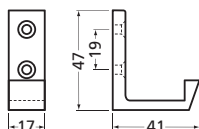
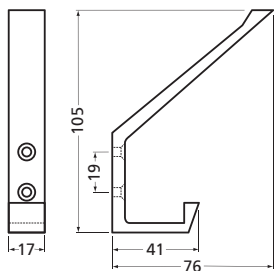

HOED- EN JASHAKEN



0148



0149

HOED- en JASHAKEN van aluminium profiel, geanodiseerd	HUT- und MANTEL- HAKEN Leichtmetall, eloxiert	HAT and COAT HOOKS extruded aluminium, anodized	CROCHETS PORTE- CHAPEAU et PORTE- MANTEAU en profilé d'aluminium, anodisé
-01 naturel -02 nieuwzilver -11 mat naturel	-01 silber -02 neusilber -11 matt silber	-01 silver -02 continental -11 matt silver	-01 argent -02 champagne -11 argent mat

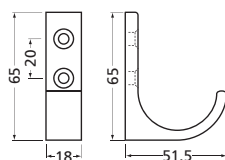
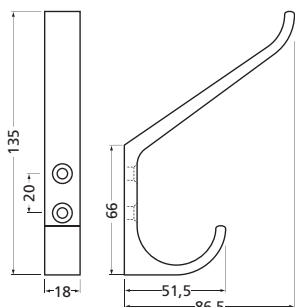

HOED- EN JASHAKEN



O200



O201

JASHAAK voor PLA-FONDBEVESTIGING aluminium, geanodiseerd	MANTELHAKEN für DECKEN-BEFESTIGUNG Leichtmetall, eloxiert	COAT HOOK for CEILING MOUNTING aluminium, anodized	CROCHET pour FIXATION au PLAFOND aluminium, anodisé
O200 vast voor 2 jassen	O200 fest für 2 Mäntel	O200 fixed for 2 coats	O200 fixe pour 2 vestes
O201 draaibaar voor 4 jassen	O201 drehbar für 4 Mäntel	O201 rotatable for 4 coats	O201 tournant pour 4 vestes
-01 naturel	-01 silber	-01 silver	-01 argent

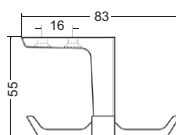
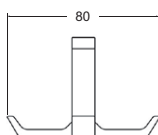
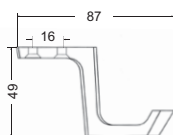
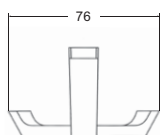

HOED- EN JASHAKEN

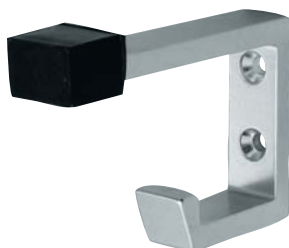

0202

JASHAAK met BUFFER van aluminium profiel, geanodiseerd	MANTELHAKEN mit PUFFER Leichtmetall, eloxiert	BUFFERED COAT HOOK extredud aluminium, anodized	CROCHET PORTE- MANTEAU avec BUTOIR en profilé d'aluminium, anodisé
-01 naturel	-01 silber	-01 silver	-01 argent
buffer van zwart rubber	Puffer aus schwarzem Gummi	black rubber buffer	butoir en caoutchouc noir

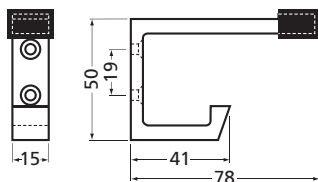

HOED- EN JASHAKEN



0690



0670

HOED- en JASHAKEN van aluminium profiel, geanodiseerd	HUT- und MANTEL- HAKEN Leichtmetall, eloxiert	HAT and COAT HOOKS extruded aluminium, anodized	CROCHETS PORTE- CHAPEAU et PORTE- MANTEAU en profilé d'aluminium, anodisé
-01 naturel -02 nieuwzilver	-01 silber -02 neusilber	-01 silver -02 continental	-01 argent -02 champagne
met bevestigingsgaten 2 x M5	mit 2 x M5 Gewindebohrungen	with 2x M5 threaded holes	avec 2 trous taraudés M5

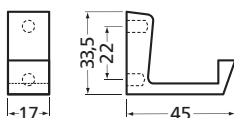
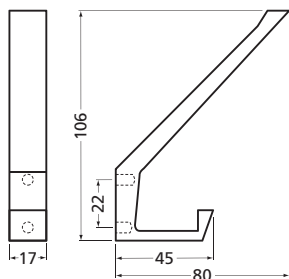

HOED- EN JASHAKEN



HOED- en JASHAKEN gegoten aluminium, geanodiseerd	HUT- und MANTEL- HAKEN Leichtmetall, eloxiert	HAT and COAT HOOKS cast aluminium, anodized	CROCHETS PORTE- CHAPEAU et PORTE- MANTEAU en fonte d'aluminium, anodisé
-01 naturel -02 nieuwzilver	-01 silber -02 neusilber	-01 silver -02 continental	-01 argent -02 champagne
met bevestigingsgaten 2 x M5	mit 2 x M5 Gewinde- bohrungen	with 2 x M5 threaded holes	avec 2 trous taraudés M5

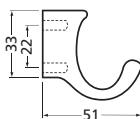
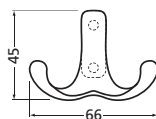
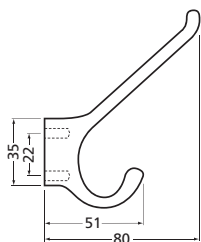
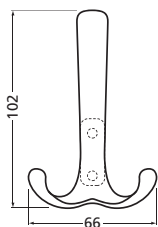

HOED- EN JASHAKEN

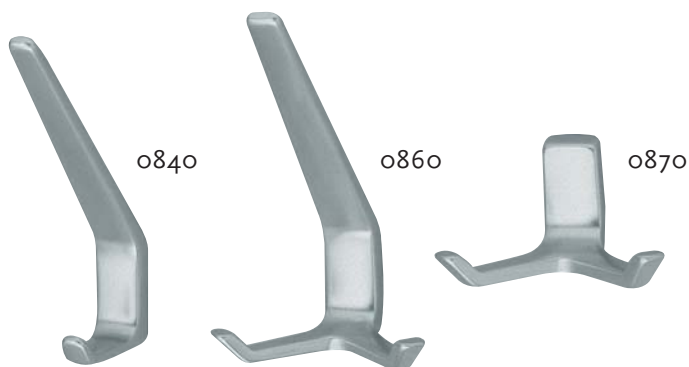

HOED- en JASHAKEN gegoten aluminium, geanodiseerd	HUT- und MANTEL- HAKEN Leichtmetall, eloxiert	HAT and COAT HOOKS cast aluminium, anodized	CROCHETS PORTE- CHAPEAU et PORTE- MANTEAU en fonte d'aluminium, anodisé
-01 naturel -02 nieuwzilver	-01 silber -02 neusilber	-01 silver -02 continental	-01 argent -02 champagne
met bevestigingsgaten 2 x M5	mit 2 x M5 Gewinde- bohrungen	with 2 x M5 threaded holes	avec 2 trous taraudés M5

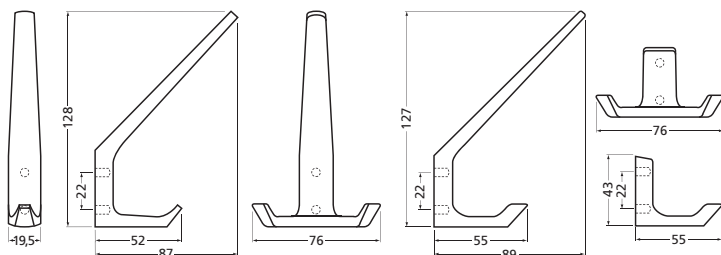

HOED- EN JASHAKEN



o880



o890

HOED- en JASHAKEN van aluminium profiel, geanodiseerd	HUT- und MANTEL- HAKEN Leichtmetall, eloxiert	HAT and COAT HOOKS extruded aluminium, anodized	CROCHETS PORTE- CHAPEAU et PORTE- MANTEAU en profilé d'aluminium, anodisé
-o1 naturel	-o1 silber	-o1 silver	-o1 argent
met bevestigingsgaten 2 x M5	mit 2 x M5 Gewinde- bohrungen	with 2x M5 threaded holes	avec 2 trous taraudés M5

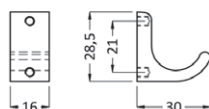
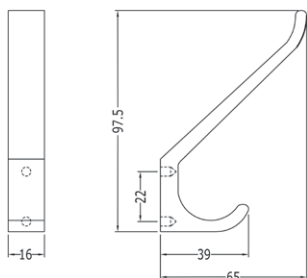

ALUMINIUM HANDDOEKHAKEN



HANDDOEKHAKEN gegoten aluminium, geanodiseerd	HANDTUCHHAKEN Leichtmetall, eloxiert	TOWEL HOOKS cast aluminium, anodized	CROCHETS pour ESSUIE-MAINS en fonte d'aluminium, anodisé
-01 naturel -02 nieuwzilver	-01 silber -02 neusilber	-01 silver -02 continental	-01 argent -02 champagne

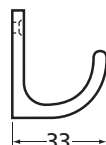
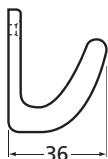
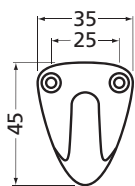

ALUMINIUM HANDDOEKHAKEN



HANDDOEKHAKEN	HANDTUCHHAKEN	TOWEL HOOKS	CROCHETS pour ESSUIE-MAINS
van aluminium profiel, geanodiseerd 0555 -01 naturel -02 nieuwzilver	Leichtmetall, eloxiert 0555 -01 silber -02 neusilber	extruded aluminium, anodized 0555 -01 silver -02 continental	en profilé d'aluminium anodisé 0555 -01 argent -02 champagne
gegoten aluminium 0557 -70 zwart geëpoxeerd -79 wit geëpoxeerd -93 vernikkeld	Leichtmetall 0557 -70 schwarz kunststoff-beschichtet -79 weiss kunststoff-beschichtet -93 vernikkelt	cast aluminium 0557 -70 black epoxy plastic coated -79 white epoxy plastic coated -93 nickel plated	en fonte d'aluminium 0559 -70 noir rilsanisé -79 blanc rilsanisé -93 nickelé
0559 -79 wit geëpoxeerd -93 vernikkeld	0559 -79 weiss kunststoff-beschichtet -93 vernikkelt	0559 -79 white epoxy plastic coated -93 nickel plated	0559 -79 blanc rilsanisé -93 nickelé

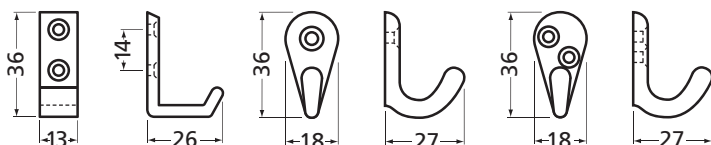

ALUMINIUM HANDDOEKHAKEN

0560



HANDDOEKHAKEN gegoten aluminium	HANDTUCHHAKEN Leichtmetall	TOWEL HOOKS cast aluminium	CROCHETS pour ESSUIE-MAINS en fonte d'aluminium
-79 wit geëpoxeerd -93 vernikkeld	-79 weiss kunststoff- beschichtet -93 vernickelt	-79 white epoxy plastic coated -93 nickel plated	-79 blanc rilsanisé -93 nickelé

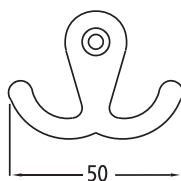
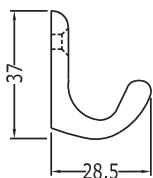

ALUMINIUM HANDDOEKKREKJES



HANDDOEKKREKJES van aluminium profiel	HANDTUCHLEISTEN Leichtmetall	TOWEL HOOKS on RAILS extruded aluminium	PORTE-SERVIETTES en profilé d'aluminium
geanodiseerd -01 naturel -02 nieuwzilver -11 mat naturel	eloxiert -01 silber -02 neusilber -11 matt silber	anodized -01 silver -02 continental -11 matt silver	anodisé -01 argent -02 champagne -11 argent mat
geëpoxeerd -79 wit	kunststoffbeschichtet -79 weiss	epoxy plastic coated -79 white	rilsanisé -79 blanc
met eikenhouten lijst en aluminium (-01) haken -36 eikenhout, geborsteld	mit Leiste aus Eichen- holz und Aluminium (-01) Haken -36 Eichenholz, gebürstet	with oak rail and aluminium (-01) hooks -36 oak wood, brushed	avec bande en chêne et d'aluminium (-01) crochets -36 chêne, brossé

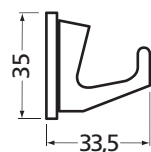
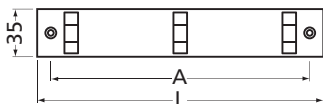

	A	L
o652	110 mm	130 mm
o653	190 mm	210 mm
o654	160 mm	280 mm
o655	240 mm	360 mm
o652-36	110 mm	150 mm
o653-36	190 mm	230 mm
o654-36	160 mm	280 mm
o655-36	240 mm	360 mm

ALUMINIUM HANDDOEKREKJES



o663



o665

HANDDOEKREKJES van aluminium profiel, geanodiseerd	HANDTUCHLEISTEN Leichtmetall, eloxiert	TOWEL HOOKS on RAILS extruded aluminium, anodized	PORTE-SERVIETTES en profilé d'aluminium, anodisé
-01 naturel -11 mat naturel	-01 silber -11 matt silber	-01 silver -11 matt silver	-01 argent -11 argent mat

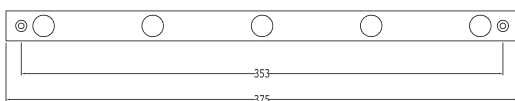
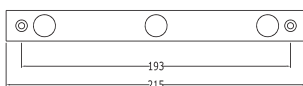

ALUMINIUM HANDDOEKREKJES



0683



0685

HANDDOEKREKJES van aluminium profiel, geanodiseerd	HANDTUCHLEISTEN Leichtmetall, eloxiert	TOWEL HOOKS on RAILS extruded aluminium, anodized	PORTE-SERVIETTES en profilé d'aluminium, anodisé
-01 naturel	-01 silber	-01 silver	-01 argent

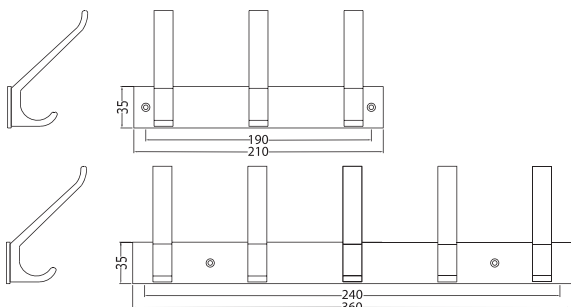

ALUMINIUM KASTROEDEBUIS

1900

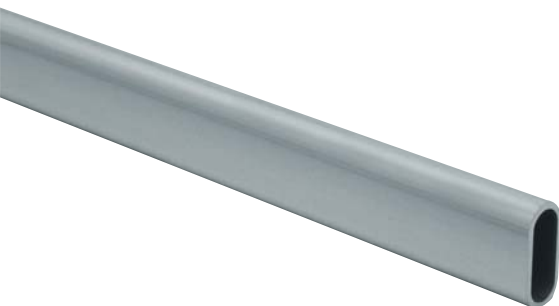

KASTROEDEBUIS	SCHRANKROHRE	CUPBOARD TUBE	TUBES D'ARMOIRE
recht ovaal aluminium profiel 30 x 14 x 2 mm geanodiseerd	flach oval Alu-Profil 30 x 14 x 2 mm eloxiert	flat oval aluminium profile 30 x 14 x 2 mm anodized	ovale et aplatie en profilé d'aluminium 30 x 14 x 2 mm anodisé
1900 leverlengte 5000 mm	1900 lieferlänge 5000 mm	1900 standard length 5000 mm	1900 longueur standard 5000 mm
1909 leverlengte 3000 mm	1909 lieferlänge 3000 mm	1909 standard length 3000 mm	1909 longueur standard 3000 mm
-11 mat naturel -12 mat nieuwzilver	-11 matt silber -12 matt neusilber	-11 matt silver -12 matt continental	-11 argent mat -12 champagne mat
STEUNEN IN DE DAG	WANDLAGER für SEIT- LICHE BEFESTIGUNG	END BRACKETS for SIDE WALL MOUNTING	SUPPORTS D'EXTRIMITES POUR FIXATION LATERALE
Zie pagina 159	Siehe Seite 159	See page 159	Voir page 159



ALUMINIUM SCHUIFHAKEN



SCHUIFHAKEN	SCHIEBEHAKEN	SLIDING HOOKS	CROCHETS GLISSANT
0591 van aluminium profiel, voor buis \varnothing 19 mm geanodiseerd -01 naturel -02 nieuwzilver -11 mat naturel	0591 Leichtmetall, für Rohr \varnothing 19 mm eloxiert -01 silber -02 neusilber -11 matt silber	0591 extruded aluminium, for tube \varnothing 19 mm anodized -01 silver -02 continental -11 matt silver	0591 en profilé d'aluminium, pour \varnothing 19 mm tube anodisé -01 argent -02 champagne -11 argent mat
SCHUIFHAKEN	SCHIEBEHAKEN	SLIDING HOOKS	CROCHETS GLISSANT
1205 van aluminium profiel, voor buis recht ovaal 30x14 en 30x15 mm geanodiseerd -01 naturel -02 nieuwzilver -93 vernikkeld	1205 Leichtmetall, für Rohr flachoval 30x14 und 30x15 mm eloxiert -01 silber -02 neusilber -93 vernickelt	1205 extruded aluminium, for tube flat oval 30x14 and 30x15 mm anodized -01 silver -02 continental -93 nickel plated	1205 en profilé d'aluminium pour ovale et aplatie tube 30x14 et 30x15 mm anodisé -01 argent -02 champagne -93 nickelé

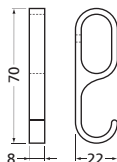
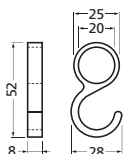

ALUMINIUM KAPSTOKGARNITUREN



KAPSTOKGARNITUREN	GARDEROBELEISTEN	COAT RACKS	PORTE-MANTEAUX
<p>0692-0695 haken 0690 van aluminium profiel, gemonteerd op gardereblijst, geanodiseerd</p> <p>-01 naturel -02 nieuwzilver</p> <p>Ook leverbaar met haken 0670 Bestelnummers 0672-0675</p> <p>Montagemiddelen ter voorkoming van diefstal zie pagina 39</p>	<p>0692-0695 Leichtmetall, Haken 0690 montiert auf Leiste, eloxiert</p> <p>-01 silber -02 neusilber</p> <p>Leisten können auch mit Haken 0670 geliefert werden. Bestellnummer 0672-0675</p> <p>Montagezubehör für Diebstahlschutz siehe Seite 39</p>	<p>0692-0695 extruded aluminium hooks 0690 on back rail, anodized</p> <p>-01 silver -02 continental</p> <p>Also available with hooks 0670 Pattern numbers 0672-0675</p> <p>Fixing kit for theft prevention see page 39</p>	<p>0692-0695 crochets 0690 et plaque de base en profilé d'aluminium, anodisé</p> <p>-01 argent -02 champagne</p> <p>Ce porte-manteau peut être livré également avec des crochets 0670 Référence 0672-0675</p> <p>Fixations pour prévenir le vol voir page 39</p>

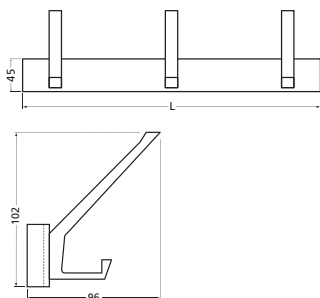

	L
0692	250 mm
0693	410 mm
0694	570 mm
0695	730 mm

ALUMINIUM KAPSTOKGARNITUREN

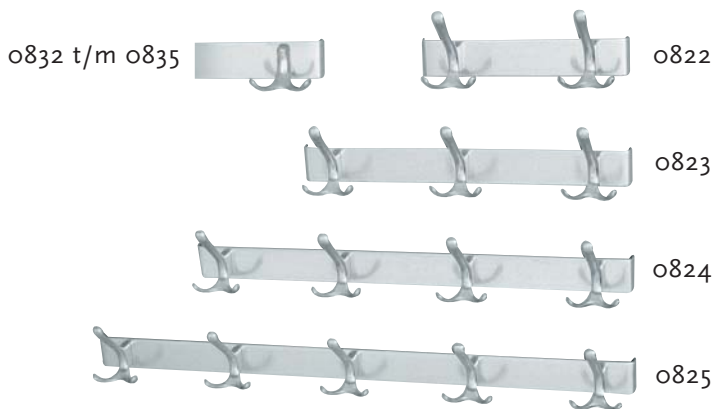

KAPSTOKGARNITUREN	GARDEROBELEISTEN	COAT RACKS	PORTE-MANTEAUX
o822-o825 gegooten aluminium haken o820 gemonteerd op garderobelijst, geanodiseerd	o822-o825 Leichtmetall, Haken o820 montiert auf Profilleiste, eloxiert	o822-o825 cast aluminium hooks o820 on back rail, anodized	o822-o825 crochets en fonte d'aluminium o820 , montés sur une plaque de base, anodisé
-01 naturel -02 nieuwzilver	-01 silber -02 neusilber	-01 silver -02 continental	-01 argent -02 champagne
Ook leverbaar met haken o830 . Bestelnummers o832-o835	Leisten können auch mit Haken o830 geliefert werden. Bestellnummer o832-o835	Also available with hooks o830 . Pattern numbers o832-o835	Ce porte-manteau peut être livré également avec des crochets o830 . Référence o832-o835
Montagemiddelen ter voorkoming van diefstal zie pagina 39	Montagezubehör für Diebstahlschutz siehe Seite 39	Fixing kit for theft prevention see page 39	Fixations pour prévenir le vol voir page 39

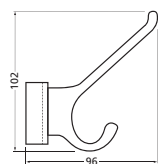
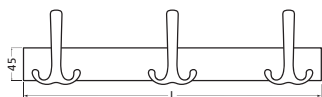

	L
o822	250 mm
o823	410 mm
o824	570 mm
o825	730 mm

ALUMINIUM KAPSTOKGARNITUREN

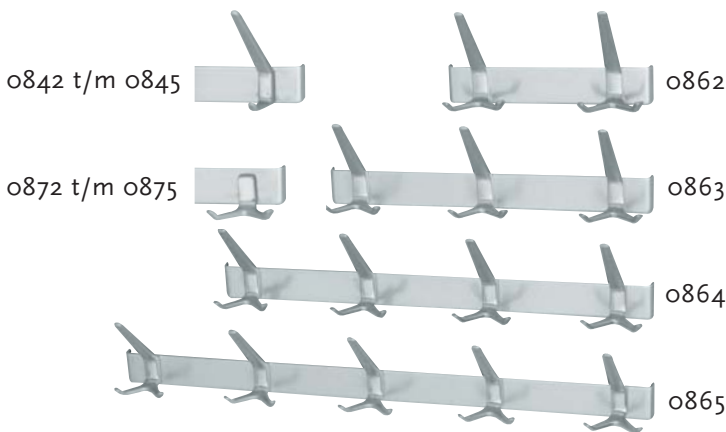

KAPSTOKGARNITUREN	GARDEROBELEISTEN	COAT RACKS	PORTE-MANTEAUX
<p>o862-o865 gegoten aluminium haken o860 gemonteerd op garderobelijst, geanodiseerd</p> <p>-01 naturel -02 nieuwzilver</p> <p>Ook leverbaar met haken o840, bestelnummers o842-o845 of met haken o870, bestelnummers o872-o875</p> <p>Montagemiddelen ter voorkoming van diefstal zie pagina 39</p>	<p>o862-o865 Leichtmetall, Haken o860 montiert auf Profilleiste, eloxiert</p> <p>-01 silber -02 neusilber</p> <p>Leisten können auch mit Haken o840 geliefert werden, Bestellnummer o842-o845 oder mit Haken o870, Bestellnummer o872-o875</p> <p>Montagezubehör für Diebstahlschutz siehe Seite 39</p>	<p>o862-o865 cast aluminium hooks o860 on back rail, anodized</p> <p>-01 silver -02 continental</p> <p>Also available with hooks o840, pattern numbers o842-o845 or with hooks o870, pattern numbers o872-o875</p> <p>Fixing kit for theft prevention see page 39</p>	<p>o862-o865 crochets en fonte d'aluminium o860, montés sur une plaque de base, anodisé</p> <p>-01 argent -02 champagne</p> <p>Ce porte-manteau peut être livré également avec des crochets o840, référence o842-o845 ou avec des crochets o870, référence o872-o875</p> <p>Fixations pour prévenir le vol voir page 39</p>

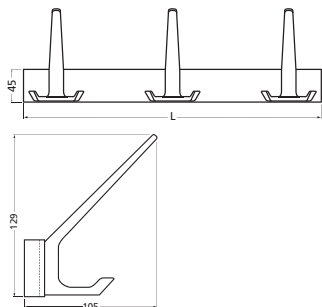

	L
o862	250 mm
o863	410 mm
o864	570 mm
o865	730 mm

ALUMINIUM KAPSTOKGARNITUREN



o863-70



o863-7979



o863-74



o863-754



o863-79

KAPSTOKGARNITUREN	GARDEROBELEISTEN	COAT RACKS	PORTE-MANTEAUX
o863 Haken en lijst in dezelfde kleur	o863 Haken und Leiste in gleiche Farbe	o863 Hooks and profile in the same color	o863 Crochets et profilé de même colour
-70 graphite black -7979 pure white	-70 graphite black -7979 pure white	-70 graphite black -7979 pure white	-70 graphite black -7979 pure white
Haken naturel geanodiseerd en lijst in kleur	Haken Silber eloxiert und Leiste in Farbe	Hooks silver anodized and profile in color	Crochets en argent anodisé et profilé dans couleur
-74 graphite grey -754 blue haze -79 pure white	-74 graphite grey -754 blue haze -79 pure white	-74 graphite grey -754 blue haze -79 pure white	-74 graphite grey -754 blue haze -79 pure white
Montagemiddelen ter voorkoming van diefstal zie pagina 39	Montagezubehör für Diebstahlschutz siehe Seite 39	Fixing kit for theft prevention see page 39	Fixations pour prévenir le vol voir page 39

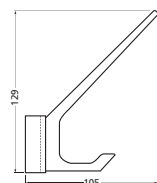
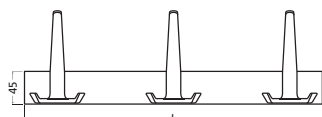

	L
o863	410 mm

ALUMINIUM KAPSTOKGARNITUREN

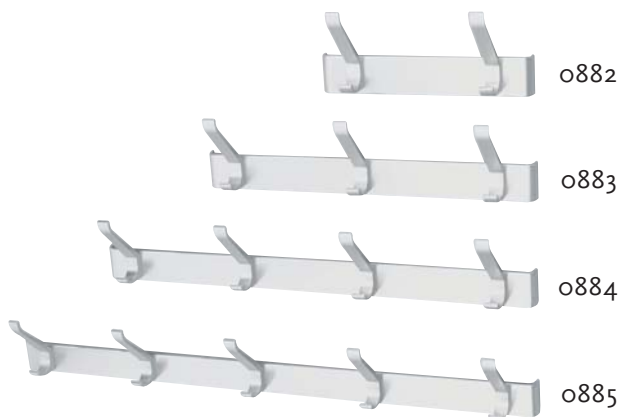

KAPSTOKGARNITUREN	GARDEROBELEISTEN	COAT RACKS	PORTE-MANTEAUX
<p>o882-o885 haken o880 van aluminium profiel, gemonteerd op garderobelijst, geanodiseerd</p> <p>-01 naturel</p> <p>Montagemiddelen ter voorkoming van diefstal zie pagina 39</p>	<p>o882-o885 Leichtmetall, Haken o880 montiert auf Leiste, eloxiert</p> <p>-01 silber</p> <p>Montagezubehör für Diebstahlschutz siehe Seite 39</p>	<p>o882-o885 extruded aluminium hooks o880 on back rail, anodized</p> <p>-01 silver</p> <p>Fixing kit for theft prevention see page 39</p>	<p>o882-o885 crochets o880, et plaque de base en profilé d'aluminium anodisé</p> <p>-01 argent</p> <p>Fixations pour prévenir le vol voir page 39</p>

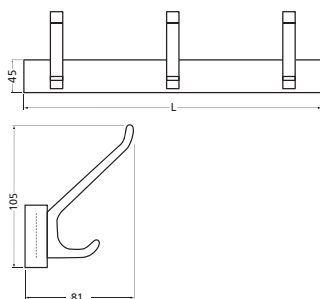

	L
o882	250 mm
o883	410 mm
o884	570 mm
o885	730 mm

MONTAGESETS ANTIDIEFSTAL

0898 | 0899



MONTAGESETS antidiefstal t.b.v. kapstokgarnituren, aluminium, geanodiseerd	MONTAGEZUBEHÖR Anti-diefstahl für Garderobenleisten, Leichtmetall, eloxiert	FIXING KIT anti-theft for coat racks, aluminium, anodized	FIXATIONS anti-vol pour porte-manteaux, aluminium, anodisé
-01 naturel -02 nieuwzilver 0898 voor de 2, 3 en 4 haaks kapstok- garnituren 0899 voor de 5 haaks kapstokgarnituren	-01 silber -02 neusilber 0898 für die Garderobenleisten mit 2, 3 und 4 Haken 0899 für die Garderobenleisten mit 5 Haken	-01 silver -02 continental 0898 for the coat racks with 2, 3 and 4 hooks 0899 or the coat racks with 5 hooks	-01 argent -02 champagne 0898 pour le porte- manteaux avec 2, 3 et 4 crochets 0899 pour le porte- manteaux avec 5 crochets

ALUMINIUM WANDGARDEROBE

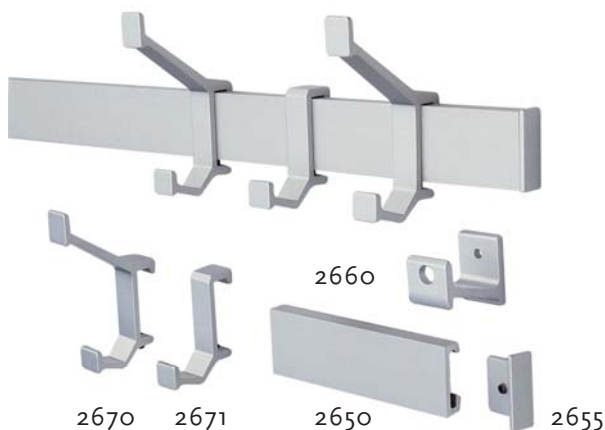

WANDGARDEROBE van aluminium profiel, geanodiseerd	WANDGARDEROBE Leichtmetall, eloxiert	COAT RACK extruded aluminium, anodized	PORTE-MANTEAU en profilé d'aluminium, anodisé
bestaande uit: 2650 lijst 42 x 13mm leverlengte 5000 mm. 2660 steunen 2670 en 2671 haken 2655 eindstops	zusammengestellt aus: 2650 Leiste 42 x 13mm Lieferlänge 5000 mm. 2660 Träger 2670 und 2671 Haken 2655 Endkappen	consisting of: 2650 back rail 42 x 13mm standard length 5000 mm. 2660 brackets 2670 and 2671 hooks 2655 end caps	composé de: 2650 profil 42 x 13mm longueur standard 5000 mm. 2660 supports 2670 et 2671 crochets 2655 embouts
-11 mat naturel	-11 matt silber	-11 matt silver	-11 argent mat

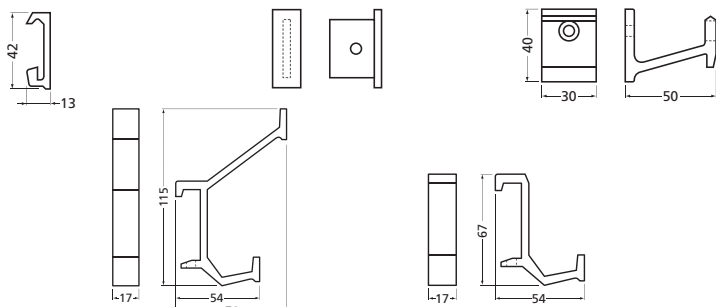

ALUMINIUM WANDGARDEROBE

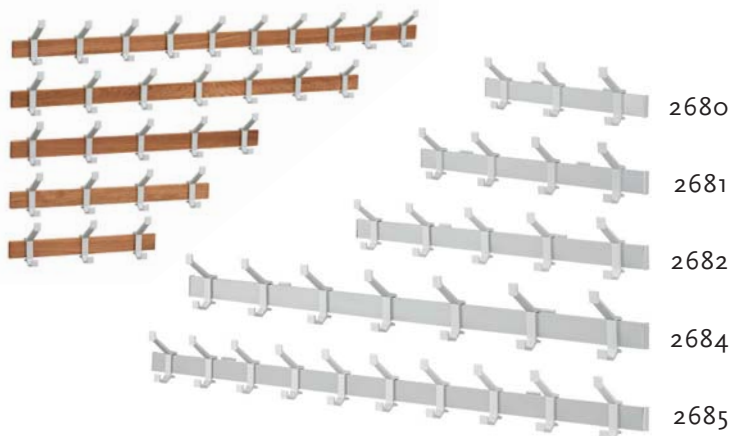

WANDGARDEROBE	WANDGARDEROBE	COAT RACK	PORTE-MANTEAU
2680 met 3 haken	2680 mit 3 Haken	2680 with 3 hooks	2680 avec 3 crochets
2681 met 4 haken	2681 mit 4 Haken	2681 with 4 hooks	2681 avec 4 crochets
2682 met 5 haken	2682 mit 5 Haken	2682 with 5 hooks	2682 avec 5 crochets
2684 met 7 haken	2684 mit 7 Haken	2684 with 7 hooks	2684 avec 7 crochets
2685 met 10 haken	2685 mit 10 Haken	2685 with 10 hooks	2685 avec 10 crochets
-11 mat naturel geanodiseerd -36 eikenhouten lijst, geborsteld en aluminium (-11) haken	-11 matt silber eloxiert -36 Leiste aus Eichen- holz, gebürstet und Aluminium (-11) Haken	-11 matt silver anodized -36 oak wood rail, brushed and aluminium (-11) hooks	-11 argent mat -36 bande en chêne, brossé et d'aluminium (-11) crochets

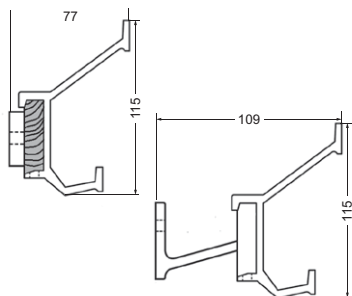

	L (-11)	L (-36)
2680	410 mm	400 mm
2681	570 mm	560 mm
2682	730 mm	720 mm
2684	1050 mm	1040 mm
2685	1250 mm	1240 mm

ALUMINIUM KAPSTOK

o8o4

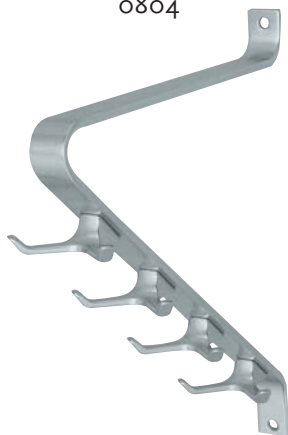

KAPSTOK	HAKENLEISTE	COAT HOOK STRIP	PORTE-MANTEAU
aluminium, geanodiseerd, 4 dubbele jashaken op strip 25 x 6 mm	Leichtmetall, eloxiert, 4 Doppelhaken montiert auf Schrägleiste 25 x 6 mm	aluminium anodized, 4 double coat hooks mounted on 25 x 6 mm strip	en aluminium, anodisé, avec 4 crochets doubles montés sur un profilé 25 x 6 mm
-01 naturel -02 nieuwzilver	-01 silber -02 neusilber	-01 silver -02 continental	-01 argent -02 champagne

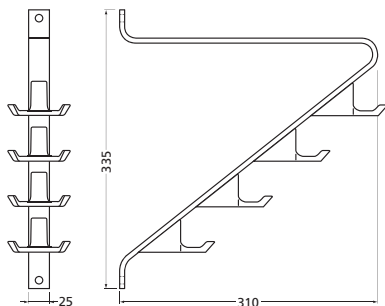

ALUMINIUM KAPSTOK



KAPSTOK aluminium, geanodiseerd, 5 draaibare hoed-/jashaken	HAKENLEISTE Leichtmetall, eloxiert, 5 drehbare hut-/mantelhaken	COAT HOOK STRIP aluminium anodized, 5 swivelling hat-/coat hooks	PORTE-MANTEAU en aluminium, anodisé, 5 pivotante chapeau-/porte-manteau
-01 naturel	-01 silber	-01 silver	-01 argent

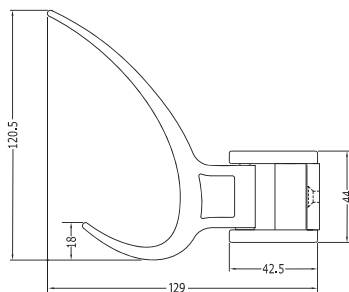



46

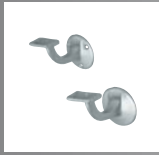

47

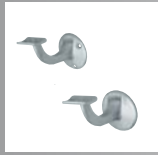

48



49



50



51



52



53



54

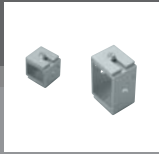

55

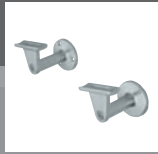

56



57



58



59

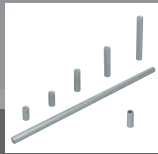

61



63

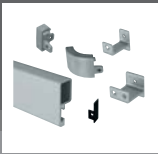

65



LEUNINGHOUDERS
EN WANDLEUNING

HANDLAUFSTÜTZEN
UND HANDLÄUFE

HANDRAIL BRACKETS
AND HANDRAILS

SUPPORTS DE MAIN COURANTE
ET MAIN COURANTE

ALUMINIUM LEUNINGHOUDERS



3500



3501

LEUNINGHOUDER 65 mm gegoten aluminium	HANDBLAUFSTÜTZE 65 mm Leichtmetall	HANDRAIL BRACKET 65 mm cast aluminium	SUPPORT de MAIN COURANTE 65 mm en fonte d'aluminium
3500 holzadel, opschroevend 3501 holzadel, tapgat M8	3500 gewölbte Auflage, 3 Bohrungen 3501 gewölbte Auflage, Gewindebohrung M8	3500 radiused saddle, 3 fixing holes 3501 radiused saddle, M8 threaded hole	3500 concave, 3 trous de montage 3501 concave, trou taraudé M8
geanodiseerd -01 naturel -02 nieuwzilver	eloxiert -01 silber -02 neusilber	anodized -01 silver -02 continental	anodisé -01 argent -02 champagne
geëpoxeerd -70 zwart -79 wit	kunststoffbeschichtet -70 schwarz -79 weiss	epoxy plastic coated -70 black -79 white	rilsanisé -70 noir -79 blanc

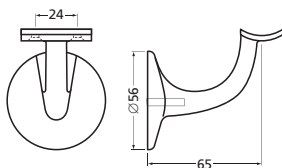
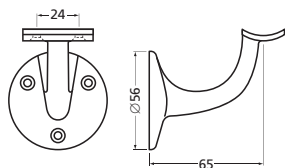

ALUMINIUM LEUNINGHOUDERS

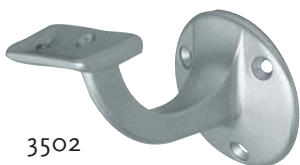

3502



3503

LEUNINGHOUDER 65 mm gegoten aluminium	HANDBLAUFSTÜTZE 65 mm Leichtmetall	HANDRAIL BRACKET 65 mm cast aluminium	SUPPORT de MAIN COURANTE 65 mm en fonte d'aluminium
3502 vlakzadel, opschroevend 3503 vlakzadel, tapgat M8	3502 gerade Auflage, 3 Bohrungen 3503 gerade Auflage, Gewindebohrung M8	3502 flat saddle, 3 fixing holes 3503 flat saddle, M8 threaded hole	3502 plat, 3 trous de montage 3503 plat, trou taraudé M8
geanodiseerd -01 naturel -02 nieuwzilver	eloxiert -01 silber -02 neusilber	anodized -01 silver -02 continental	anodisé -01 argent -02 champagne
geëpoxeerd (alleen 3502) -70 zwart -79 wit	kunststoffbeschichtet (nür 3502) -70 schwarz -79 weiss	epoxy plastic coated (3502 only) -70 black -79 white	rilsanisé (seulement 3502) -70 noir -79 blanc

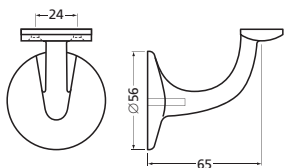
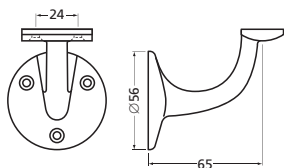

ALUMINIUM LEUNINGHOUDERS



3505



3506

LEUNINGHOUDER 75 mm gegoten aluminium, geanodiseerd	HANDBLAUFSTÜTZE 75 mm Leichtmetall, eloxiert	HANDRAIL BRACKET 75 mm cast aluminium, anodized	SUPPORT de MAIN COURANTE 75 mm en fonte d'aluminium, anodisé
3505 holzadel, op- schroevend 3506 holzadel, tapgat M8	3505 gewölbte Auflage, 3 Bohrungen 3506 gewölbte Auflage, Gewindebohrung M8	3505 radiused saddle, 3 fixing holes 3506 radiused saddle, M8 threaded hole	3505 concave, 3 trous de montage 3506 concave, trou taraudé M8
-01 naturel -02 nieuwzilver	-01 silber -02 neusilber	-01 silver -02 continental	-01 argent -02 champagne

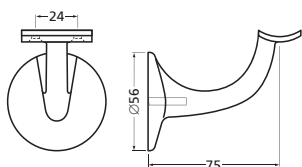
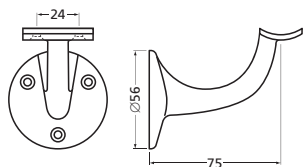

ALUMINIUM LEUNINGHOUDERS



LEUNINGHOUDER 75 mm gegoten aluminium, geanodiseerd	HANDBLAUFSTÜTZE 75 mm Leichtmetall, eloxiert	HANDRAIL BRACKET 75 mm cast aluminium, anodized	SUPPORT de MAIN COURANTE 75 mm en fonte d'aluminium, anodisé
3507 vlakzadel, op- schroevend 3508 vlakzadel, tapgat M8	3507 gerade Auflage, 3 Bohrungen 3508 gerade Auflage, Gewindebohrung M8	3507 flat saddle, 3 fixing holes 3508 flat saddle, M8 threaded hole	3507 plat, 3 trous de montage 3508 plat, trou taraudé M8
-01 naturel -02 nieuwzilver	-01 silber -02 neusilber	-01 silver -02 continental	-01 argent -02 champagne

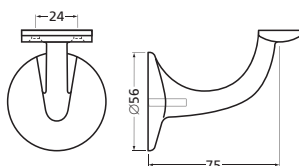
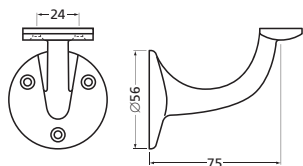

ALUMINIUM LEUNINGHOUDERS



3540



3541

LEUNINGHOUDER 65 mm van aluminium profiel, geanodiseerd	HANDBLAUFSTÜTZE 65 mm Leichtmetall, eloxiert	HANDRAIL BRACKET 65 mm extruded aluminium, anodized	SUPPORT de MAIN COURANTE 65 mm en profilé d'aluminium anodisé
3540 vlakzadel, op- schroevend 3541 vlakzadel, met gat voor stokschroef M8	3540 gerade Auflage, zum Aufschrauben 3541 gerade Auflage, mit Loch für M8- Schraube	3540 flat saddle, for screw fixing 3541 flat saddle, with single hole for M8 fixing bolt	3540 plat, pour fixation au mur par vis 3541 plat, avec trou pour boulon M8
-01 naturel -02 nieuwzilver -11 mat naturel	-01 silber -02 neusilber -11 matt silber	-01 silver -02 continental -11 matt silver	-01 argent -02 champagne -11 argent mat

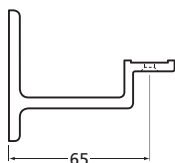
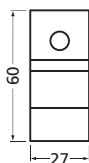
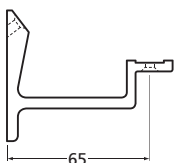
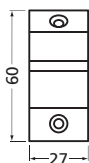

ALUMINIUM LEUNINGHOUDERS



LEUNINGHOUDER 65 mm van aluminium profiel, geanodiseerd	HANDBLAUFSTÜTZE 65 mm Leichtmetall, eloxiert	HANDRAIL BRACKET 65 mm extruded aluminium, anodized	SUPPORT de MAIN COURANTE 65 mm en profilé d'aluminium, anodisé
3542 holzadel, op- schroevend 3543 holzadel, met gat voor stokschroef M8	3542 gewölbte Auflage zum Aufschrauben 3543 gewölbte Auflage, mit Loch für M8 Schraube	3542 radiused saddle, for screw holes 3543 radiused saddle, with single hole for M8 fixing bolt	3542 concave, pour fixation au mur par vis 3543 concave, avec trou pour boulon M8
-01 naturel -02 nieuwzilver -11 mat naturel	-01 silber -02 neusilber -11 matt silber	-01 silver -02 continental -11 matt silver	-01 argent -02 champagne -11 argent mat

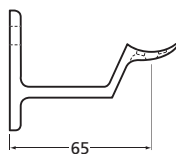
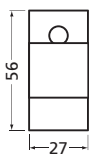
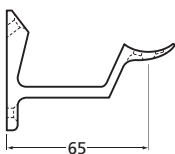
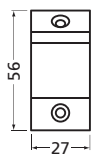

ALUMINIUM LEUNINGHOUDERS



3545



3546

LEUNINGHOUDER 75 mm van aluminium profiel, geanodiseerd	HANDBLAUFSTÜTZE 75 mm Leichtmetall, eloxiert	HANDRAIL BRACKET 75 mm extruded aluminium, anodized	SUPPORT de MAIN COURANTE 75 mm en profilé d'aluminium, anodisé
3545 vlakzadel, op- schroevend 3546 vlakzadel, met gat voor stokschroef M8	3545 gerade Auflage, zum Aufschrauben 3546 gerade Auflage, mit Loch für M8- Schraube	3545 flat saddle, for screw fixing 3546 flat saddle, with single hole for M8 fixing bolt	3545 plat, pour fixation au mur par vis 3546 plat, avec trou pour boulon M8
-01 naturel -02 nieuwzilver -11 mat naturel	-01 silber -02 neusilber -11 matt silber	-01 silver -02 continental -11 matt silver	-01 argent -02 champagne -11 argent mat

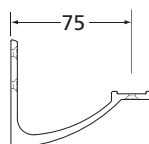
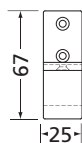
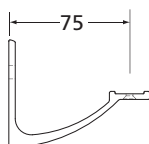
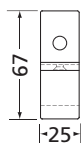

ALUMINIUM LEUNINGHOUDERS



3547



3548

LEUNINGHOUDER 75 mm aluminium profiel, geanodiseerd	HANDBLAUFSTÜTZE 75 mm Leichtmetall, eloxiert	HANDRAIL BRACKET 75 mm extruded aluminium, anodized	SUPPORT de MAIN COURANTE 75 mm en profilé d'aluminium, anodisé
3547 holzadel, op- schroevend 3548 holzadel, met gat voor stokschroef M8	3547 gewölbte Auflage, zum Aufschrauben 3548 gewölbte Auflage, mit Loch für M8- Schraube	3547 radiused saddle, for screw fixing 3548 radiused saddle, with single hole for M8 fixing bolt	3547 concave, pour fixation au mur par vis 3548 concave, avec trou pour boulon M8
-01 naturel -02 nieuwzilver -11 mat naturel	-01 silber -02 neusilber -11 matt silber	-01 silver -02 continental -11 matt silver	-01 argent -02 champagne -11 argent mat

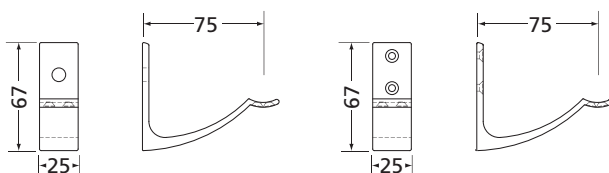

ALUMINIUM AFSTANDHOUDERS

3570



3585



LEUNINGHOUDER	HANDLAUFSTÜTZE	HANDRAIL BRACKET	SUPPORT de MAIN COURANTE
3570 52 mm aluminium profiel, geanodiseerd	3570 52 mm Leichtmetall, eloxiert	3570 52 mm extruded aluminium, anodized with single hole for M8 fixing bolt	3570 52 mm en profilé d'aluminium anodisé
-01 naturel -02 nieuwzilver -11 mat naturel	-01 silber -02 neusilber -11 matt silber	-01 silver -02 continental -11 matt silver	-01 argent -02 champagne -11 argent mat
AFSTANDHOUDER	ABSTANDHALTER	BRACKET	SUPPORT
3585 40 x 38 mm aluminium geanodiseerd doorgaand tapgat M8	3585 40 x 38 mm Leichtmetall eloxiert durchgehende Gewindebohrung M8	3585 40 x 38 mm aluminium anodized trough threaded hole M8	3585 40 x 38 mm aluminium anodisé trou taraudé M8
-01 naturel -02 nieuwzilver -11 mat naturel	-01 silber -02 neusilber -11 matt Silber	-01 silver -02 continental -11 matt silver	-01 argent -02 champagne -11 argent mat

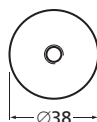
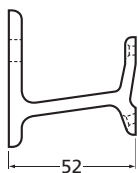
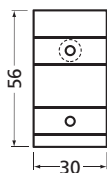

VERSTELBARE AFSTANDHOUDERS

3580



3581



AFSTANDHOUDER, VERSTELBAAR aluminium profiel, geanodiseerd	ABSTANDHALTER, VERSTELLBAR Leichtmetall, eloxiert	ADJUSTABLE BRACKET extruded aluminium, anodized	SUPPORT, REGLABLE en profilé d'aluminium, anodisé
3580 instelbaar tussen 44 en 56 mm	3580 verstelbaar zwischen 44 bis 56 mm	3580 adjustable between 44 and 56 mm	3580 réglable entre 44 et 56 mm
3581 instelbaar tussen 55 en 76 mm	3581 verstelbaar zwischen 55 bis 76 mm	3581 adjustable between 55 and 76 mm	3581 réglable entre 55 et 76 mm
-11 mat naturel	-11 matt silber	-11 matt silver	-11 argent mat

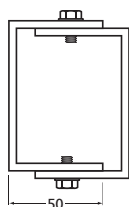
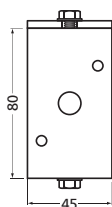
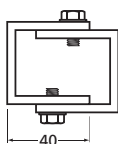
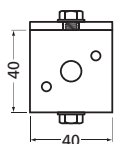

SAMENGESTELDE LEUNINGHOUDERS

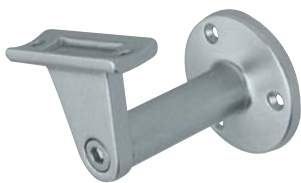

$$3515 = \begin{pmatrix} 3511 \\ + \\ 3521 \\ + \\ 5990 \end{pmatrix}$$

$$3510 = \begin{pmatrix} 3516 \\ + \\ 3521 \\ + \\ 5990 \end{pmatrix}$$

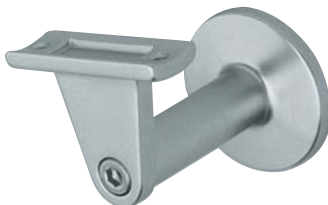

LEUNINGHOUDER	HANDBLAUFSTÜTZE	HANDRAIL BRACKET	SUPPORT de MAIN COURANTE
75 mm, samengesteld, gegoten aluminium, geanodiseerd	75 mm, zusammengesetzt, Leichtmetall, eloxiert	75 mm, composed, cast aluminium, anodized	75 mm, composé, en fonte d'aluminium, anodisé
3510 holzadel, op-schroevend	3510 gewölbte Auflage, 3 Bohrungen	3510 radiused saddle, 3 fixing holes	3510 concave, 3 trous de montage
3515 holzadel, tapgat M8	3515 gewölbte Auflage, Gewindebohrung M8	3515 radiused saddle, M8 threaded hole	3515 concave, trou taraudé M8
-01 naturel -02 nieuwzilver	-01 silber -02 neusilber	-01 silver -02 continental	-01 argent -02 champagne

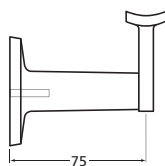
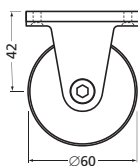
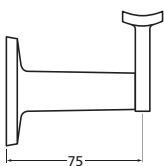
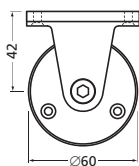

SAMENGESTELDE LEUNINGHOUDERS

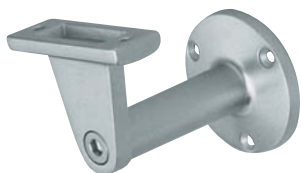

$$3520 = \begin{pmatrix} 3516 \\ + \\ 3522 \\ + \\ 5990 \end{pmatrix}$$

$$3525 = \begin{pmatrix} 3511 \\ + \\ 3522 \\ + \\ 5990 \end{pmatrix}$$

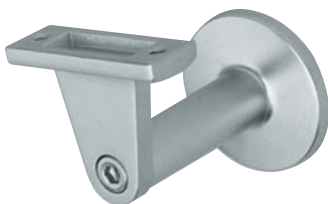

LEUNINGHOUDER	HANDBLAUFSTÜTZE	HANDRAIL BRACKET	SUPPORT de MAIN COURANTE
75 mm, samengesteld, gegoten aluminium, geanodiseerd	75 mm, zusammengesetzt, Leichtmetall, eloxiert	75 mm, composed, cast aluminium, anodized	75 mm, composé, en fonte d'aluminium, anodisé
3520 vlakzadel, opschroevend	3520 gerade Auflage, 3 Bohrungen	3520 flat saddle, 3 fixing holes	3520 plat, 3 trous de montage
3525 vlakzadel, tapgat M8	3525 gerade Auflage, Gewindebohrung M8	3525 flat saddle, M8 threaded hole	3525 plat, trou taraudé M8
-01 naturel -02 nieuwzilver	-01 silber -02 neusilber	-01 silver -02 continental	-01 argent -02 champagne

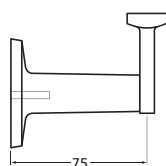
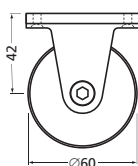
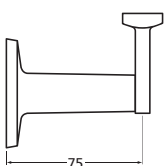
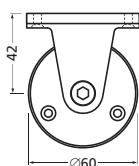

ROZET MET VASTE ZUIL



ROZET met VASTE ZUIL gegoten aluminium, geanodiseerd	HANDBLAUFSTÜTZE ohne AUFLAGE Leichtmetall, eloxiert	HANDRAIL BRACKET without SADDLE cast aluminium, anodized	SUPPORT de MAIN COURANTE sans SELLE en fonte d'aluminium, anodisé
met tapgat M8 3511 - L= 71 mm 3512 - L= 96 mm 3513 - L= 121 mm 3514 - L= 106 mm	Gewindebohrung M8 3511 - L= 71 mm 3512 - L= 96 mm 3513 - L= 121 mm 3514 - L= 106 mm	M8 threaded hole 3511 - L= 71 mm 3512 - L= 96 mm 3513 - L= 121 mm 3514 - L= 106 mm	trou taraudé M8 3511 - L= 71 mm 3512 - L= 96 mm 3513 - L= 121 mm 3514 - L= 106 mm
opschroevend 3516 - L= 71 mm	3 Bohrungen 3516 - L= 71 mm	3 fixing holes 3516 - L= 71 mm	3 trous de montage 3516 - L= 71 mm
-01 naturel -02 nieuwzilver	-01 silber -02 neusilber	-01 silver -02 continental	-01 argent -02 champagne

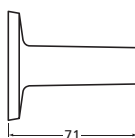
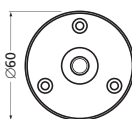
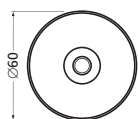

ZADELS VOOR LEUNINGHOUDERS

5990



3521



3522



3523

3524

3526

3527

ZADEL voor LEUNINGHOUDER gegoten aluminium, geanodiseerd	AUFLAGE für HANDLAUFSTÜTZE Leichtmetall, eloxiert	SADDLE for HANDRAIL BRACKET cast aluminium, anodized	SELLE pour SUPPORT de MAIN en fonte d'aluminium, anodisé
<p>3521 - rond 3522 - vlak 3523 - voor Ø 40 mm 3524 - voor Ø 50 mm 3526 - voor Ø 40 mm 3527 - voor Ø 50 mm</p> <p>-01 naturel -02 nieuwzilver</p> <p>5990-99 Inbusbout M8 x 16 van RVS</p>	<p>3521 - gewölbt 3522 - gerade 3523 - für Ø 40 mm 3524 - für Ø 50 mm 3526 - für Ø 40 mm 3527 - für Ø 50 mm</p> <p>-01 silber -02 neusilber</p> <p>5990-99 Zylinderschraube mit Innensechskant M8 x 16 aus Edelstahl</p>	<p>3521 - radiused 3522 - flat 3523 - for Ø 40 mm 3524 - for Ø 50 mm 3526 - for Ø 40 mm 3527 - for Ø 50 mm</p> <p>-01 silver -02 continental</p> <p>5990-99 Socket head cap screws, pilot recess M8 x 16, stainless steel</p>	<p>3521 - concave 3522 - plat 3523 - pour Ø 40 mm 3524 - pour Ø 50 mm 3526 - pour Ø 40 mm 3527 - pour Ø 50 mm</p> <p>-01 argent -02 champagne</p> <p>5990-99 Vis à tête cylindrique à six pans creux, M8 x 16 en acier inoxydable</p>

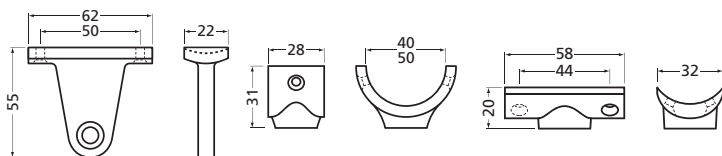

ZUILEN VOOR LEUNINGHOUDERS

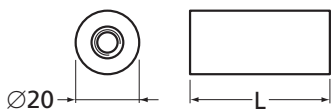

3530 ... 3536

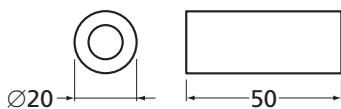

3537

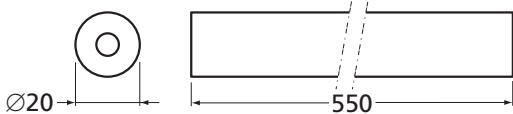

3538

ZUILEN VOOR LEUNINGHOUDERS

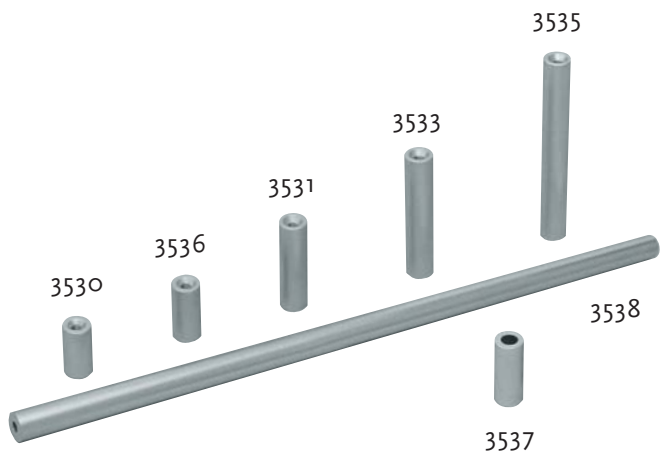

ZUIJL voor LEUNINGHOUDER aluminum, Ø 20 mm met 2 x M8, geanodiseerd	SÄULE für HANDLAUFSTÜTZE Leichtmetall, Ø 20 mm mit 2 x M8, eloxiert	PILLAR for HANDRAIL-BRACKET aluminum, Ø 20 mm with 2 x M8, anodized	COLONNE pour SUPPORT de MAIN aluminum, Ø 20 mm avec 2 x M8, anodisé
3530 - L = 39 mm 3531 - L = 71 mm 3533 - L = 100 mm 3535 - L = 150 mm 3536 - L = 44 mm	3530 - L = 39 mm 3531 - L = 71 mm 3533 - L = 100 mm 3535 - L = 150 mm 3536 - L = 44 mm	3530 - L = 39 mm 3531 - L = 71 mm 3533 - L = 100 mm 3535 - L = 150 mm 3536 - L = 44 mm	3530 - L = 39 mm 3531 - L = 71 mm 3533 - L = 100 mm 3535 - L = 150 mm 3536 - L = 44 mm
met gat rond 11 mm 3537 - L = 50 mm	mit Bohrung 11 mm 3537 - L = 50 mm	with hole 11 mm 3537 - L = 50 mm	avec trou 11 mm 3537 - L = 50 mm
met gat rond 6,5 mm 3538 - L = 550 mm	mit Bohrung 6,5 mm 3538 - L = 550 mm	with hole 6,5 mm 3538 - L = 550 mm	avec trou 6,5 mm 3538 - L = 550 mm
-01 naturel -02 nieuwzilver	-01 silber -02 neusilber	-01 silver -02 continental	-01 argent -02 champagne

ROZETTEN VOOR LEUNINGHOUDERS

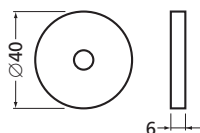

3562

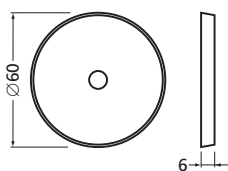

3564

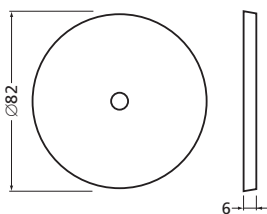

3566

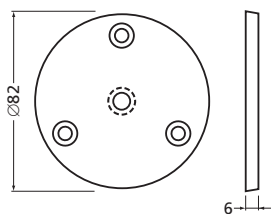

3567

ROZETTEN VOOR LEUNINGHOUDERS

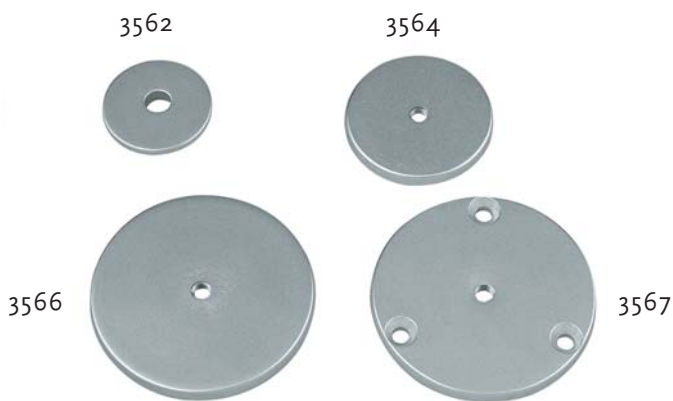

ROZET voor LEUNINGHOUDER gegoten aluminium, geanodiseerd	MONTAGEPLATTE für HANDLAUFSTÜTZE Leichtmetall, eloxiert	ROSETTE for HAND- RAIL BRACKET cast aluminium, anodized	COLONNE pour SUPPORT de MAIN en fonte d'aluminium, anodisé
<p>3562 Ø 40 mm met gat 8,5 mm</p> <p>3564 Ø 60 mm met gat 8,5 mm</p> <p>3566 Ø 82 mm met gat 8,5 mm</p> <p>3567 Ø 82 mm met 3 schroefgaten</p>	<p>3562 Ø 40 mm, mit Bohrung 8,5 mm</p> <p>3564 Ø 60 mm, mit Bohrung 8,5 mm</p> <p>3566 Ø 82 mm, mit Bohrung 8,5 mm</p> <p>3567 Ø 82 mm mit 3 Bohrungen</p>	<p>3562 Ø 40 mm with hole 8,5 mm</p> <p>3564 Ø 60 mm with hole 8,5 mm</p> <p>3566 Ø 82 mm with hole 8,5 mm</p> <p>3567 Ø 82 mm with 3 fixing holes</p>	<p>3562 Ø 40 mm avec trou 8,5 mm</p> <p>3564 Ø 60 mm avec trou 8,5 mm</p> <p>3566 Ø 82 mm avec trou 8,5 mm</p> <p>3567 Ø 82 mm avec 3 trous</p>
<p>-01 naturel</p> <p>-02 nieuwzilver</p>	<p>-01 silber</p> <p>-02 neusilber</p>	<p>-01 silver</p> <p>-02 continental</p>	<p>-01 argent</p> <p>-02 champagne</p>

ALUMINIUM WANDLEUNINGSYSTEM

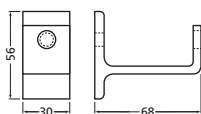

3440

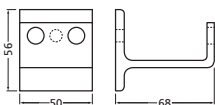

3441

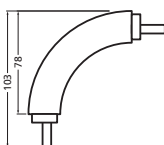

3445

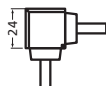
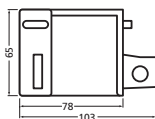

3446

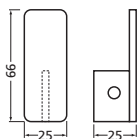
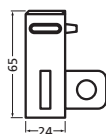

3435



3430

ALUMINIUM WANDLEUNINGSYSTEEM

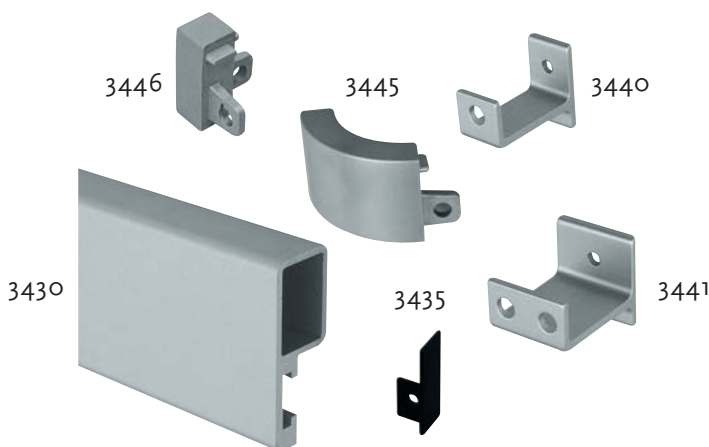

WANDLEUNING	HANDLAUF	HANDRAIL	MAIN COURANTE
3430 65 x 25 mm aluminium profiel, geanodiseerd, leverlengte 6000 mm -11 mat naturel	3430 65 x 25 mm Alu-profil, eloxiert, Lieferlänge 6000 mm -11 matt silber	3430 65 x 25 mm aluminium profile, anodized, standard length 6000 mm -11 matt silver	3430 65 x 25 mm en profilé d'aluminium, anodisé, longueur standard 6000 mm -11 argent mat
LEUNINGHOUDERS	HANDLAUFSTÜTZEN	HANDRAIL BRACKETS	SUPPORTS de MAIN COURANTE
3440, 3441 van aluminium profiel, geanodiseerd, incl. bevest. materiaal voor monteren wandleuning -11 mat naturel (3441 wordt gebruikt voor het koppelen van 2 leuningprofielen)	3440, 3441 Leichtmetall, eloxiert, einschl. Befestigungsmaterial für Montage der Handläufe -11 matt silber (3441 zur Verbindung von 2 Handläufen)	3440, 3441 extruded aluminium, anodized, including fixings for mounting of handrail -11 matt silver (3441 to be used at joint of 2 handrails)	3440, 3441 en profilé d'aluminium, anodisé, visserie pour la pose de la main courante incluse -11 argent mat (On utilise 3441 à la jonction de main courantes)
BUITENHOEK (3445) resp. BINNENHOEK (3446)	ECKSTÜCK AUSSEN (3445) bzw. INNEN (3446)	EXTERNAL BEND (3445) CORNERPIECE INTERNAL (3446)	RACCORD D'ANGLE EXTERIEUR (3445) ou INTERIEUR (3446)
van gegoten aluminium, geanodiseerd, incl. bevestigingsmateriaal voor montage aan wandleuning 3430 -11 mat naturel	Leichtmetall, eloxiert, einschl. Befestigungsmaterial für Montage mit dem Handlauf 3430 -11 matt silber	cast aluminium, anodized, including fixings for mounting with handrail 3430 -11 matt silver	en fonte d'aluminium, anodisé, visserie pour la pose avec la main courante 3430 incluse -11 argent mat
EINDSTOP	ENDSTÜCK	ENDCAP	EMBOUT
3435 voor wandleuning 3430, aluminium, geanodiseerd, incl. bevestigingsmateriaal -18 zwart	3435 für Handlauf 3430, Leichtmetall, eloxiert, einschl. Befestigungsmaterial -18 schwarz	3435 for handrail 3430, aluminium, anodized, including fixings -18 black finish	3435 pour main courante 3430, en aluminium, anodisé, visserie pour la pose incluse -18 noir



68...87



88...94



95



96



97



98



99



100



101



102



103



104



105



106



107



108



109



110



111

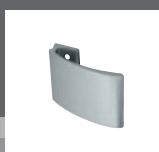

112



113

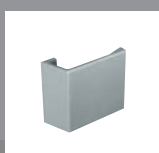

114

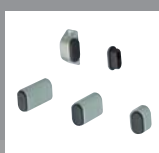

115



116



117

**GREPEN, MEUBELKNOPPEN,
DEURDUWERS EN DEURBUFFERS**

**GRIFFE, MÖBELKNÖPFE,
TÜRGRIFFE UND TÜRPUFFER**

**PULL HANDLES, CUPBOARD KNOBS,
PUSH PADS AND DOOR CHECKS**

**POIGNEES, BOUTONS
de MEUBLE, POIGNEES de PORTE
ET ARRÊTS de PORTE**

ALUMINIUM MEUBELGREPEN

F1101096 | F1101128 | F1101160



MEUBELGREPEN van aluminium profiel met tapgat M4	MÖBELGRIFFE Leichtmetall Gewinde- bohrungen M4	CABINET HANDLES extruded aluminium M4 threaded holes	POIGNEES DE MEUBLE en profilé d'aluminium trou taraudé M4
geanodiseerd -11 mat naturel	eloxiert -11 matt silber	anodized -11 matt silver	anodisé -11 argent mat

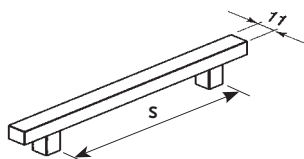

	S
F1101096	96 mm
F1101128	128 mm
F1101160	160 mm

ALUMINIUM MEUBELGREPEN

F1111128 | F1111160



MEUBELGREPEN van aluminium profiel met tapgat M4	MÖBELGRIFFE Leichtmetall Gewinde- bohrungen M4	CABINET HANDLES extruded aluminium M4 threaded holes	POIGNEES DE MEUBLE en profilé d'aluminium trou taraudé M4
geanodiseerd -11 mat naturel	eloxiert -11 matt silber	anodized -11 matt silver	anodisé -11 argent mat

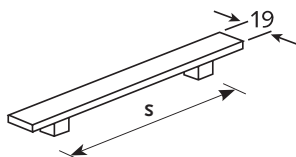

	S
F1111128	128 mm
F1111160	160 mm

ALUMINIUM MEUBELGREPEN

F1161096 | F1161128 | F1161160



MEUBELGREPEN van aluminium profiel met tapgat M4	MÖBELGRIFFE Leichtmetall Gewinde- bohrungen M4	CABINET HANDLES extruded aluminium M4 threaded holes	POIGNEES DE MEUBLE en profilé d'aluminium trou taraudé M4
geanodiseerd -11 mat naturel	eloxiert -11 matt silber	anodized -11 matt silver	anodisé -11 argent mat

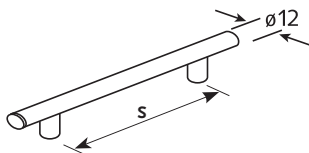

	S
F1161096	96 mm
F1161128	128 mm
F1161160	160 mm

ALUMINIUM MEUBELGREPEN

F1201096 | F1201128 | F1201160

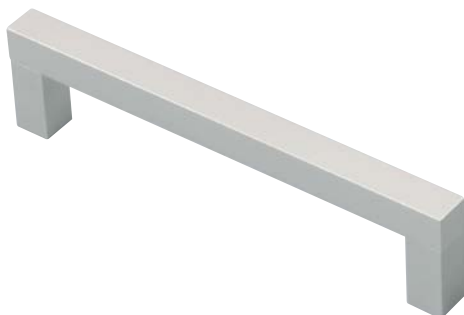

MEUBELGREPEN van aluminium profiel met tapgat M4	MÖBELGRIFFE Leichtmetall Gewinde- bohrungen M4	CABINET HANDLES extruded aluminium M4 threaded holes	POIGNEES DE MEUBLE en profilé d'aluminium trou taraudé M4
geanodiseerd -11 mat naturel	eloxiert -11 matt silber	anodized -11 matt silver	anodisé -11 argent mat

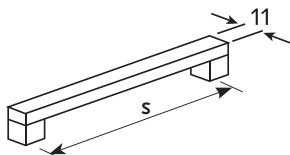

	S
F1201096	96 mm
F1201128	128 mm
F1201160	160 mm

ALUMINIUM MEUBELGREPEN

F1211128 | F1211160

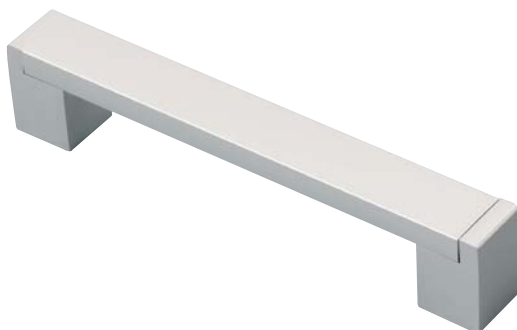

MEUBELGREPEN van aluminium profiel met tapgat M4	MÖBELGRIFFE Leichtmetall Gewinde- bohrungen M4	CABINET HANDLES extruded aluminium M4 threaded holes	POIGNEES DE MEUBLE en profilé d'aluminium trou taraudé M4
geanodiseerd -11 mat naturel	eloxiert -11 matt silber	anodized -11 matt silver	anodisé -11 argent mat

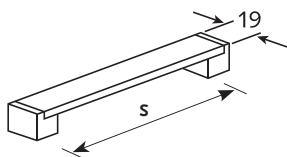

	S
F1211128	128 mm
F1211160	160 mm

ALUMINIUM MEUBELGREPEN

F1221096 | F1221128 | F1221160



MEUBELGREPEN van aluminium profiel met tapgat M4	MÖBELGRIFFE Leichtmetall Gewinde- bohrungen M4	CABINET HANDLES extruded aluminium M4 threaded holes	POIGNEES DE MEUBLE en profilé d'aluminium trou taraudé M4
geanodiseerd -11 mat naturel	eloxiert -11 matt silber	anodized -11 matt silver	anodisé -11 argent mat

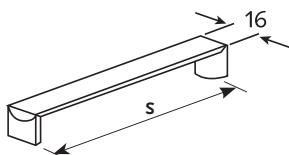

	S
F1221096	96 mm
F1221128	128 mm
F1221160	160 mm

ALUMINIUM MEUBELGREPEN

F1233096 | F1233128 | F1233160



MEUBELGREPEN van aluminium profiel met tapgat M4	MÖBELGRIFFE Leichtmetall Gewinde- bohrungen M4	CABINET HANDLES extruded aluminium M4 threaded holes	POIGNEES DE MEUBLE en profilé d'aluminium trou taraudé M4
geanodiseerd -11 mat naturel	eloxiert -11 matt silber	anodized -11 matt silver	anodisé -11 argent mat

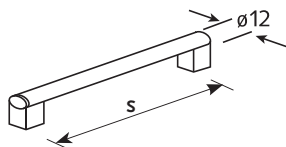

	S
F1233096	96 mm
F1233128	128 mm
F1233160	160 mm

ALUMINIUM MEUBELGREPEN

F2103160



MEUBELGREPEN van aluminium profiel met tapgat M4	MÖBELGRIFFE Leichtmetall Gewinde- bohrungen M4	CABINET HANDLES extruded aluminium M4 threaded holes	POIGNEES DE MEUBLE en profilé d'aluminium trou taraudé M4
geanodiseerd -11 mat naturel	eloxiert -11 matt silber	anodized -11 matt silver	anodisé -11 argent mat

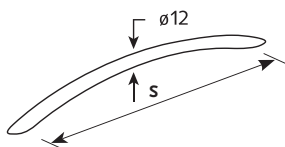

	S
F2103160	160 mm

ALUMINIUM MEUBELGREPEN

F2134160



MEUBELGREPEN van aluminium profiel met tapgat M4	MÖBELGRIFFE Leichtmetall Gewinde- bohrungen M4	CABINET HANDLES extruded aluminium M4 threaded holes	POIGNEES DE MEUBLE en profilé d'aluminium trou taraudé M4
geanodiseerd -11 mat naturel	eloxiert -11 matt silber	anodized -11 matt silver	anodisé -11 argent mat

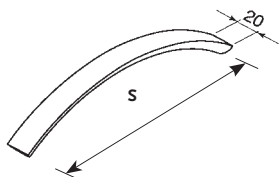

	S
F2134160	160 mm

ALUMINIUM MEUBELGREPEN

F3121064 | F3121096 | F3121128 | F3121160



MEUBELGREPEN van aluminium profiel met tapgat M4	MÖBELGRIFFE Leichtmetall Gewinde- bohrungen M4	CABINET HANDLES extruded aluminium M4 threaded holes	POIGNEES DE MEUBLE en profilé d'aluminium trou taraudé M4
geanodiseerd -11 mat naturel	eloxiert -11 matt silber	anodized -11 matt silver	anodisé -11 argent mat

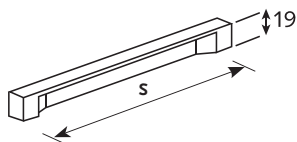

	S
F3121064	64 mm
F3121096	96 mm
F3121128	128 mm
F3121160	160 mm

ALUMINIUM MEUBELGREPEN

F3131128 | F3131160



MEUBELGREPEN van aluminium profiel met tapgat M4	MÖBELGRIFFE Leichtmetall Gewinde- bohrungen M4	CABINET HANDLES extruded aluminium M4 threaded holes	POIGNEES DE MEUBLE en profilé d'aluminium trou taraudé M4
geanodiseerd -11 mat naturel	eloxiert -11 matt silber	anodized -11 matt silver	anodisé -11 argent mat

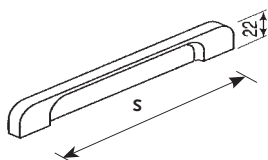

	S
F3131128	128 mm
F3131160	160 mm

ALUMINIUM MEUBELGREPEN

F3141096 | F3141128 | F3141160



MEUBELGREPEN van aluminium profiel met tapgat M4	MÖBELGRIFFE Leichtmetall Gewinde- bohrungen M4	CABINET HANDLES extruded aluminium M4 threaded holes	POIGNEES DE MEUBLE en profilé d'aluminium trou taraudé M4
geanodiseerd -11 mat naturel	eloxiert -11 matt silber	anodized -11 matt silver	anodisé -11 argent mat

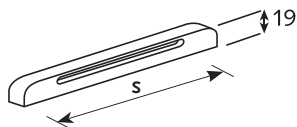

	S
F3141096	96 mm
F3141128	128 mm
F3141160	160 mm

ALUMINIUM MEUBELGREPEN

F3411096 | F3411128 | F3411160

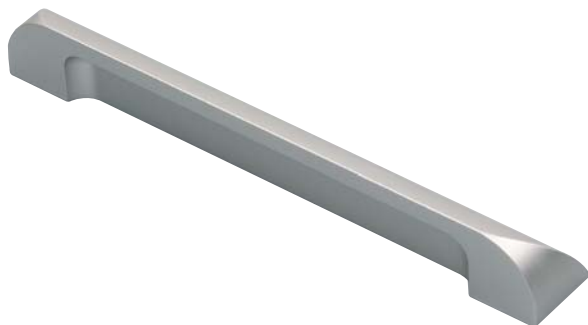

MEUBELGREPEN van aluminium profiel met tapgat M4	MÖBELGRIFFE Leichtmetall Gewinde- bohrungen M4	CABINET HANDLES extruded aluminium M4 threaded holes	POIGNEES DE MEUBLE en profilé d'aluminium trou taraudé M4
geanodiseerd -11 mat naturel	eloxiert -11 matt silber	anodized -11 matt silver	anodisé -11 argent mat

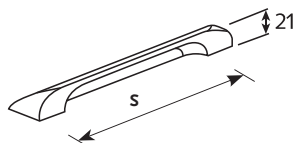

	S
F3411096	96 mm
F3411128	128 mm
F3411160	160 mm

ALUMINIUM MEUBELGREPEN

F3511064 | F3511096 | F3511128 | F3511160



MEUBELGREPEN van aluminium profiel met tapgat M4	MÖBELGRIFFE Leichtmetall Gewinde- bohrungen M4	CABINET HANDLES extruded aluminium M4 threaded holes	POIGNEES DE MEUBLE en profilé d'aluminium trou taraudé M4
geanodiseerd -11 mat naturel	eloxiert -11 matt silber	anodized -11 matt silver	anodisé -11 argent mat

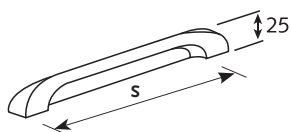

	S
F3511064	64 mm
F3511096	96 mm
F3511128	128 mm
F3511160	160 mm

ALUMINIUM MEUBELGREPEN

F3521128 | F3521160



MEUBELGREPEN van aluminium profiel met tapgat M4	MÖBELGRIFFE Leichtmetall Gewinde- bohrungen M4	CABINET HANDLES extruded aluminium M4 threaded holes	POIGNEES DE MEUBLE en profilé d'aluminium trou taraudé M4
geanodiseerd -11 mat naturel	eloxiert -11 matt silber	anodized -11 matt silver	anodisé -11 argent mat

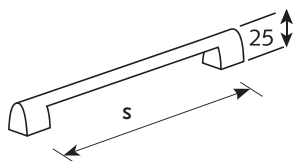

	S
F3521128	128 mm
F3521160	160 mm

ALUMINIUM MEUBELGREPEN

F3531160 | F3531192



MEUBELGREPEN van aluminium profiel met tapgat M4	MÖBELGRIFFE Leichtmetall Gewinde- bohrungen M4	CABINET HANDLES extruded aluminium M4 threaded holes	POIGNEES DE MEUBLE en profilé d'aluminium trou taraudé M4
geanodiseerd -11 mat naturel	eloxiert -11 matt silber	anodized -11 matt silver	anodisé -11 argent mat

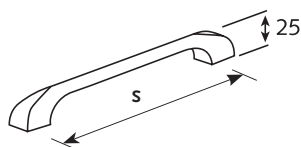

	S
F3531160	160 mm
F3531192	192 mm

ALUMINIUM MEUBELGREPEN

F3541064 | F3541096 | F3541128 | F3541160



MEUBELGREPEN van aluminium profiel met tapgat M4	MÖBELGRIFFE Leichtmetall Gewinde- bohrungen M4	CABINET HANDLES extruded aluminium M4 threaded holes	POIGNEES DE MEUBLE en profilé d'aluminium trou taraudé M4
geanodiseerd -11 mat naturel	eloxiert -11 matt silber	anodized -11 matt silver	anodisé -11 argent mat

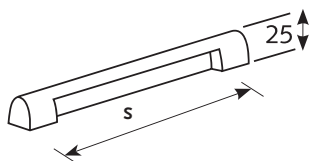

	S
F3541064	64 mm
F3541096	96 mm
F3541128	128 mm
F3541160	160 mm

ALUMINIUM MEUBELGREPEN

F3731064 | F3731096 | F3731128



MEUBELGREPEN van aluminium profiel met tapgat M4	MÖBELGRIFFE Leichtmetall Gewinde- bohrungen M4	CABINET HANDLES extruded aluminium M4 threaded holes	POIGNEES DE MEUBLE en profilé d'aluminium trou taraudé M4
geanodiseerd -11 mat naturel	eloxiert -11 matt silber	anodized -11 matt silver	anodisé -11 argent mat

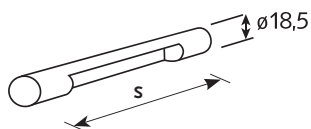

	S
F3731064	64 mm
F3731096	96 mm
F3731128	128 mm

ALUMINIUM MEUBELGREPEN

F5101128 | F5101160

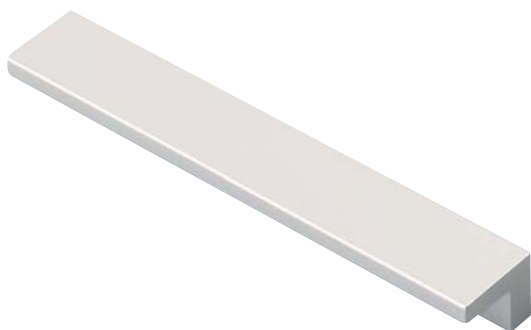

MEUBELGREPEN van aluminium profiel met tapgat M4	MÖBELGRIFFE Leichtmetall Gewinde- bohrungen M4	CABINET HANDLES extruded aluminium M4 threaded holes	POIGNEES DE MEUBLE en profilé d'aluminium trou taraudé M4
geanodiseerd -11 mat naturel	eloxiert -11 matt silber	anodized -11 matt silver	anodisé -11 argent mat

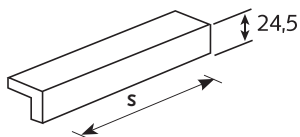

	S
F5101128	128 mm
F5101160	160 mm

ALUMINIUM MEUBELGREPEN

F5701128 | F5701160 | F5701192



MEUBELGREPEN van aluminium profiel met tapgat M4	MÖBELGRIFFE Leichtmetall Gewinde- bohrungen M4	CABINET HANDLES extruded aluminium M4 threaded holes	POIGNEES DE MEUBLE en profilé d'aluminium trou taraudé M4
geanodiseerd -11 mat naturel	eloxiert -11 matt silber	anodized -11 matt silver	anodisé -11 argent mat

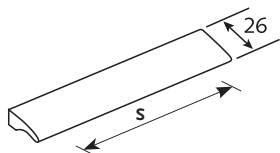

	S
F5701128	128 mm
F5701160	160 mm
F5701192	192 mm

ALUMINIUM MEUBELKNOPPEN

F3121032



MEUBELKNOPPEN van aluminium profiel met tapgat M4	MÖBELKNÖPFE Leichtmetall Gewinde- bohrung M4	CUPBOARD KNOBS extruded aluminium M4 threaded hole	BOUTONS DE MEUBLE en profilé d'aluminium trou taraudé M4
geanodiseerd -11 mat naturel	eloxiert -11 matt silber	anodized -11 matt silver	anodisé -11 argent mat

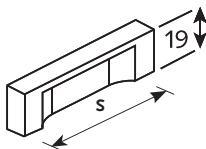

	S
F3121032	32 mm

ALUMINIUM MEUBELKNOPPEN

F3541032



MEUBELKNOPPEN van aluminium profiel met tapgat M4	MÖBELKNÖPFE Leichtmetall Gewinde- bohrung M4	CUPBOARD KNOBS extruded aluminium M4 threaded hole	BOUTONS DE MEUBLE en profilé d'aluminium trou taraudé M4
geanodiseerd -11 mat naturel	eloxiert -11 matt silber	anodized -11 matt silver	anodisé -11 argent mat

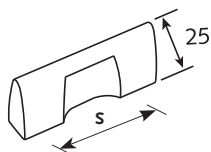

S	
F3541032	32 mm

ALUMINIUM MEUBELKNOPPEN

F3670000



MEUBELKNOPPEN van aluminium profiel met tapgat M4	MÖBELKNÖPFE Leichtmetall Gewinde- bohrung M4	CUPBOARD KNOBS extruded aluminium M4 threaded hole	BOUTONS DE MEUBLE en profilé d'aluminium trou taraudé M4
geanodiseerd -11 mat naturel	eloxiert -11 matt silber	anodized -11 matt silver	anodisé -11 argent mat

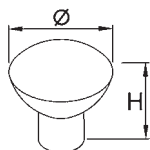

	Ø	H
3670000	30 mm	27 mm

ALUMINIUM MEUBELKNOPPEN

F3671000



MEUBELKNOPPEN van aluminium profiel met tapgat M4	MÖBELKNÖPFE Leichtmetall Gewinde- bohrung M4	CUPBOARD KNOBS extruded aluminium M4 threaded hole	BOUTONS DE MEUBLE en profilé d'aluminium trou taraudé M4
geanodiseerd -11 mat naturel	eloxiert -11 matt silber	anodized -11 matt silver	anodisé -11 argent mat

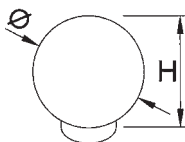

	Ø	H
3671000	25 mm	27 mm

ALUMINIUM MEUBELKNOPPEN

F5101016

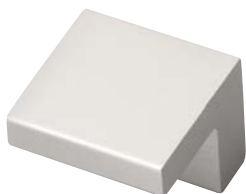

MEUBELKNOPPEN van aluminium profiel met tapgat M4	MÖBELKNÖPFE Leichtmetall Gewinde- bohrung M4	CUPBOARD KNOBS extruded aluminium M4 threaded hole	BOUTONS DE MEUBLE en profilé d'aluminium trou taraudé M4
geanodiseerd -11 mat naturel	eloxiert -11 matt silber	anodized -11 matt silver	anodisé -11 argent mat

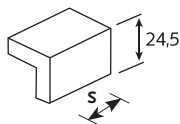

S	
F5101016	16 mm

ALUMINIUM MEUBELKNOPPEN

F5701016

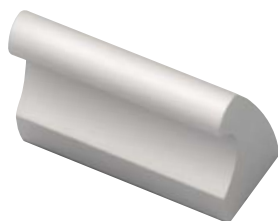

MEUBELKNOPPEN van aluminium profiel met tapgat M4	MÖBELKNÖPFE Leichtmetall Gewinde- bohrung M4	CUPBOARD KNOBS extruded aluminium M4 threaded hole	BOUTONS DE MEUBLE en profilé d'aluminium trou taraudé M4
geanodiseerd -11 mat naturel	eloxiert -11 matt silber	anodized -11 matt silver	anodisé -11 argent mat

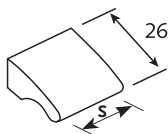

	S
F5701016	16 mm

ALUMINIUM MEUBELKNOPPEN

F5901016



MEUBELKNOPPEN van aluminium profiel met tapgat M4	MÖBELKNÖPFE Leichtmetall Gewinde- bohrung M4	CUPBOARD KNOBS extruded aluminium M4 threaded hole	BOUTONS DE MEUBLE en profilé d'aluminium trou taraudé M4
geanodiseerd -11 mat naturel	eloxiert -11 matt silber	anodized -11 matt silver	anodisé -11 argent mat

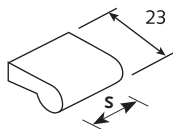

S	
F5901016	16 mm

ALUMINIUM MEUBELKNOPPEN

3755



MEUBELKNOP XL van aluminium profiel met tapgat M4	MÖBELKNÖPF XL Leichtmetall Gewindebohrung M4	CUPBOARD KNOB XL extruded aluminium M4 threaded hole	BOUTON DE MEUBLE XL en profilé d'aluminium trou taraudé M4
geanodiseerd -01 naturel -11 mat naturel	eloxiert -01 silber -11 matt silber	anodized -01 silver -11 matt silver	anodisé -01 argent -11 argent mat
geëpoxeerd -70 zwart	kunststofbeschildet -70 schwarz	epoxy plastic coated -70 black	riksanisé -70 noir

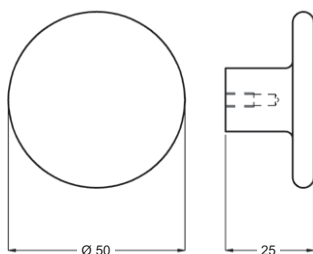

ALUMINIUM MEUBELKNOPPEN



3751



3752



3753

MEUBELKNOPPEN gegoten aluminium met schroef M4 x 25 mm	MÖBELKNÖPFE Leichtmetall mit Schraube M4 x 25 mm	CUPBOARD KNOBS cast aluminium with fixing bolt M4 x 25 mm	BOUTONS DE MEUBLE en fonte d'aluminium avec vis M4 x 25 mm
geanodiseerd -01 naturel -02 nieuwzilver	eloxiert -01 silber -02 neusilber	anodized -01 silver -02 continental	anodized -01 argent -02 champagne
geëpoxeerd -79 wit	kunststoffbeschildet -79 wit	epoxy plastic coated -79 white	epoxy plastic coated -79 white

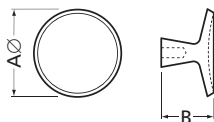

	A	B
3751	30 mm	20 mm
3752	35 mm	21 mm
3753	40 mm	22 mm

ALUMINIUM MEUBELKNOPPEN



3731



3732

MEUBELKNOPPEN van aluminium profiel cilindermodel met tapgat M4	MÖBELKNÖPFE Leichtmetall zylindrisch Gewindebohrung M4	CUPBOARD KNOBS extruded aluminium cylindrical M4 threaded hole	BOUTONS DE MEUBLE en profilé d'aluminium cylindrique trou taraudé M4
geanodiseerd -11 mat naturel	eloxiert -11 matt silber	anodized -11 matt silver	anodisé -11 argent mat
geëpoxeerd -70 zwart	kunststofbeschichtet -70 schwarz	epoxy plastic coated -70 black	rilsanisé -70 noir

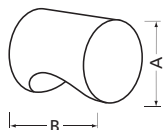

	A	B
3731	20 mm	23 mm
3732	25 mm	26 mm

ALUMINIUM LADEGREPEN



4067



4069



4087



4089

LADEGREPEN van aluminium profiel	MÖBELGRIFFE Leichtmetall	CABINET HANDLES extruded aluminium	POIGNEES DE MEUBLE en profilé d'aluminium
geanodiseerd -01 naturel -02 nieuwzilver -11 mat naturel	eloxiert -01 silber -02 neusilber -11 matt silber	anodized -01 silver -02 continental -11 matt silver	anodisé -01 argent -02 champagne -11 argent mat
met 2 x M4 bevestigingsgaten, inkl. 2 schroeven M4 x 25 mm (4067, 4069) resp. 2 x Ø 4 mm bevestigingsgaten (4087, 4089)	mit 2 Gewindebohrungen M4, komplett mit 2 Schrauben M4 x 25 mm (4067, 4069) bzw. 2 x Ø 4 mm Löcher (4087, 4089)	with 2 x M4 threaded holes and complete with 2 fixing bolts M4x25 mm (4067, 4069) or 2 x 4 mm Ø fixing holes (4087, 4089)	avec 2 x M4 trous taraudé, incluant 2 vis M4 x 25 mm (4067, 4069) ou 2 trous de montage Ø 4 mm (4087, 4089)

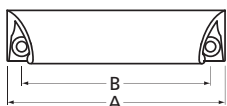
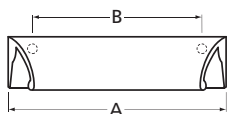

	A	B
4067	70 mm	50 mm
4069	90 mm	70 mm
4087	70 mm	58 mm
4089	90 mm	78 mm

ALUMINIUM LADEGREPEN



4193

4192

4191

4190

LADEGREPEN van aluminium profiel	MÖBELGRIFFE Leichtmetall	CABINET HANDLES extruded aluminium	POIGNEES DE MEUBLE en profilé d'aluminium
geanodiseerd -01 naturel -02 nieuwzilver -11 mat naturel	eloxiert -01 silber -02 neusilber -11 matt silber	anodized -01 silver -02 continental -11 matt silver	anodisé -01 argent -02 champagne -11 argent mat
met 2 x M4 bevestigingsgaten (4190, 4191) resp. 2 x M5 bevestigingsgaten (4192, 4193)	mit 2 Gewindebohrungen M4 (4190, 4191) bzw. M5 (4192, 4193)	with 2 x M4 threaded holes (4190, 4191) or 2 x M5 treaded holes (4192, 4193)	avec 2 x M4 trous taraudés (4190, 4191) ou 2 x M5 trous taraudés (4192, 4193)
Bevestigingsschroeven 25 mm lang worden meegeleverd.	Befestigungsschrauben 25 mm Länge werden mitgeliefert.	25 mm length fixing bolts are included.	Vis longueur 25 mm incluses.

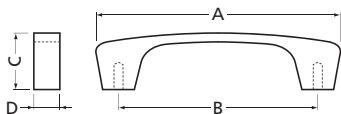

	A	B	C	D
4190	70 mm	60 mm	16 mm	8 mm
4191	85 mm	73 mm	22 mm	10 mm
4192	108 mm	88 mm	25 mm	12 mm
4193	130 mm	110 mm	29 mm	13 mm

ALUMINIUM HANDGREPEN

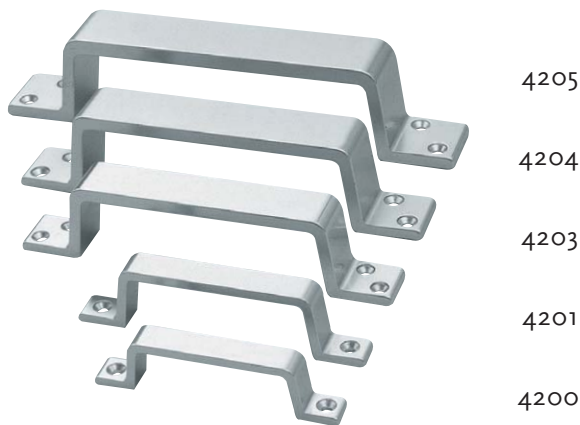

GREPEN van aluminium profiel	GRIFFE Leichtmetall	HANDLES extruded aluminium	POIGNEES en profilé d'aluminium
geanodiseerd -01 naturel -02 nieuwzilver -11 mat naturel	eloxiert -01 silber -02 neusilber -11 matt silber	anodized -01 silver -02 continental -11 matt silver	anodisé -01 argent -02 champagne -11 argent mat
geëpoxeerd (alleen 4200, 4201 en 4203) -70 zwart -79 wit	kunststoffbeschichtet (nur 4200, 4201 und 4203) -70 schwarz -79 weiss	epoxy plastic coated (4200, 4201 and 4203 only) -70 black -79 white	rilsanisé (seulement 4200, 4201 et 4203) -70 noir -79 blanc

	A	B	C	C1	C2	D	E
4200	90 mm	18 mm	78 mm			12 mm	
4201	110 mm	23 mm	95 mm			13 mm	
4203	150 mm	28 mm		120,5 mm	137,5 mm	20,5 mm	9,5 mm
4204	170 mm	32 mm		138 mm	155,5 mm	25 mm	13 mm
4205	200 mm	35 mm		162 mm	183,5 mm	29 mm	16 mm

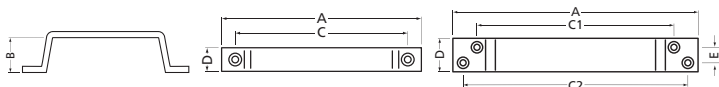

ALUMINIUM HANDGREPEN



GREPEN van aluminium profiel	GRIFFE Leichtmetall	HANDLES extruded aluminium	POIGNEES en profilé d'aluminium
geanodiseerd -01 naturel -02 nieuwzilver -11 mat naturel	eloxiert -01 silber -02 neusilber -11 matt silber	anodized -01 silver -02 continental -11 matt silver	anodisé -01 argent -02 champagne -11 argent mat

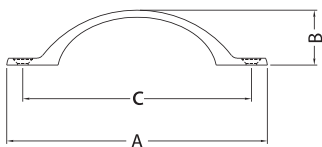

	A	B	C	D
4221	110 mm	20 mm	96 mm	14 mm
4222	146 mm	27 mm	128 mm	19 mm
4223	183 mm	34 mm	160 mm	24 mm

ALUMINIUM HANDGREPEN



4233

4232

4231

GREPEN van aluminium profiel	GRIFFE Leichtmetall	HANDLES extruded aluminium	POIGNEES en profilé d'aluminium
geanodiseerd -01 naturel -02 nieuwzilver -11 mat naturel	eloxiert -01 silber -02 neusilber -11 matt silber	anodized -01 silver -02 continental -11 matt silver	anodisé -01 argent -02 champagne -11 argent mat
geëpoxeerd (alleen 4231 en 4232) -70 zwart	kunststoffbeschichtet (nur 4231 und 4232) -70 schwarz	epoxy plastic coated (4231 and 4232 only) -70 black	rilsané (seulement 4231 et 4232) -70 noir



	A	B	C	D
4231	112 mm	21 mm	96 mm	14 mm
4232	149 mm	28 mm	128 mm	19 mm
4233	186 mm	35 mm	160 mm	24 mm

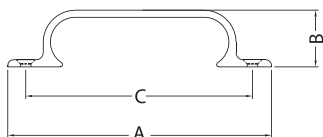

ALUMINIUM HANDGREPEN

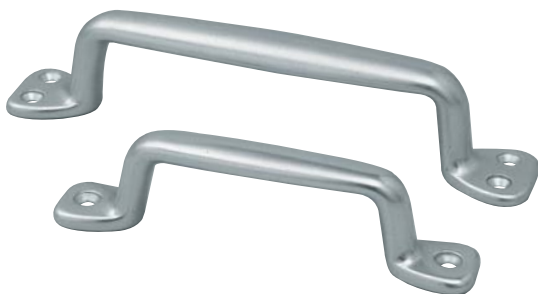

4251

4250

GREPEN gegoten aluminium	GRIFFE Leichtmetall	HANDLES cast aluminium	POIGNEES en fonte d'aluminium
geanodiseerd -01 naturel -02 nieuwzilver	eloxiert -01 silber -02 neusilber	anodized -01 silver -02 continental	anodisé -01 argent -02 champagne

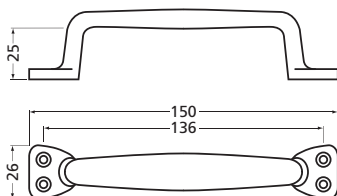
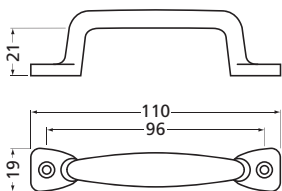

ALUMINIUM HANDGREPEN



4258

4257

4256

4255

GREPEN gegoten aluminium	GRIFFE Leichtmetall	HANDLES cast aluminium	POIGNEES en fonte d'aluminium
geanodiseerd -01 naturel -02 nieuwzilver	eloxiert -01 silber -02 neusilber	anodized -01 silver -02 continental	anodisé -01 argent -02 champagne

	A	B	C	D	E
4255	110 mm	22 mm	95 mm	36 mm	24 mm
4256	140 mm	26 mm	125 mm	38 mm	26 mm
4257	160 mm	30 mm	138 mm	42 mm	30 mm
4258	190 mm	33 mm	168 mm	47 mm	34 mm

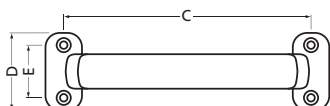
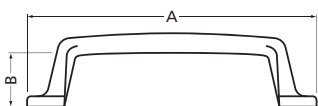

ALUMINIUM HANDGREPEN

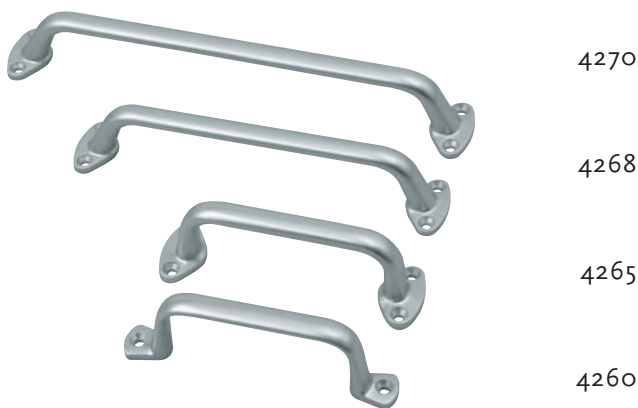

GREPEN gegoten aluminium	GRIFFE Leichtmetall	HANDLES cast aluminium	POIGNEES en fonte d'aluminium
geanodiseerd -01 naturel -02 nieuwzilver	eloxiert -01 silber -02 neusilber	anodized -01 silver -02 continental	anodisé -01 argent -02 champagne
geëpoxeerd (alleen 4265, 4268 en 4270) -79 wit	kunststofbeschildet (nur 4265, 4268 und 4270) -79 weiss	epoxy plastic coated (4265, 4268 and 4270 only) -79 white	riksanisé (seulement 4265, 4268 et 4270) -79 blanc

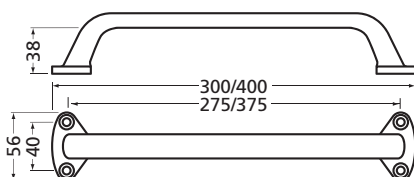
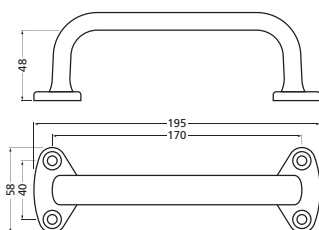
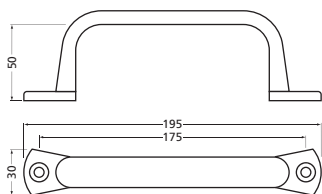

RAAMLICHTERS EN RAAMPENNEN

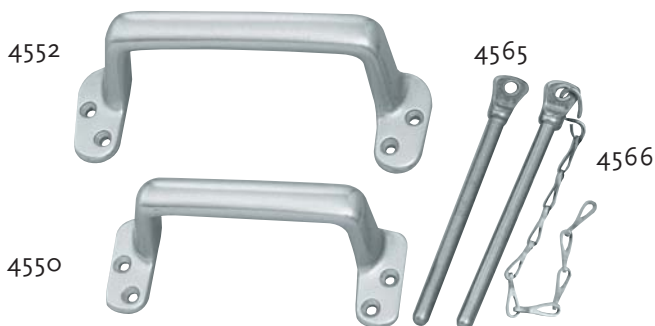

RAAMLICHTERS gegoten aluminium	GRIFFE für SCHIEBE- FENSTER Leichtmetall	HANDLES for LIFT-UP WINDOWS cast aluminium	POIGNEES pour FENE- TRES à GUILLOTINE en fonte d'aluminium
geanodiseerd -01 naturel -02 nieuwzilver	eloxiert -01 silber -02 neusilber	anodized -01 silver -02 continental	anodisé -01 argent -02 champagne
RAAMPEN gegoten aluminium	FENSTERSICHERUNG Leichtmetall	SASH PIN cast aluminium	GOUPILLE en fonte d'aluminium
-96 blank 4565 zonder ketting 4566 met ketting	-96 roh 4565 ohne Kette 4566 mit Kette	-96 unfinished 4565 without chain 4566 with chain	-96 brut 4565 sans chaîne 4566 avec chaîne

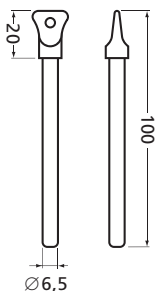

	A	B	C	D	E
4550	110 mm	89 mm	100 mm	31 mm	12 mm
4552	136 mm	106 mm	124 mm	35 mm	12 mm

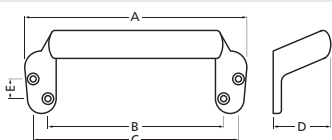

ALUMINIUM SCHUIFDEURKOMMEN

4554



4555



SCHUIFDEURKOM rond model aluminium profiel, geanodiseerd	MUSCHELGRIFFE für SCHIEBETÜR rundes Modell Leichtmetall, eloxiert	FLUSH PULL round model extruded aluminium, anodized	POIGNEE CUVETTE pour PORTE COULISSANTE en profilé d'aluminium, anodisé
-01 naturel -02 nieuwzilver	-01 silber -02 neusilber	-01 silver -02 continental	-01 argent -02 champagne

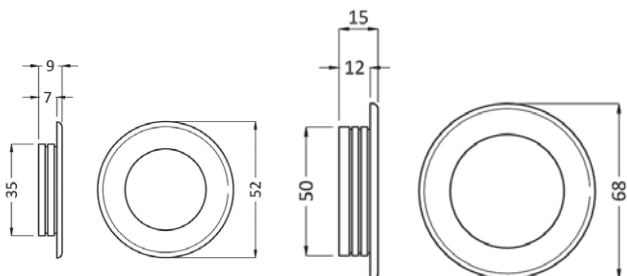

ALUMINIUM SCHUIFDEURKOMMEN

4556



4558



SCHUIFDEURKOM rechthoekig model aluminium profiel	MUSCHELGRIFFE für SCHIEBETÜR rechteckigen Leichtmetall	FLUSH PULL rectangular model extruded aluminium	POIGNEE CUVETTE pour PORTE COULISSANTE en profilé d'aluminium
geanodiseerd -01 naturel -02 nieuwzilver	eloxiert -01 silber -02 neusilber	anodized -01 silver -02 continental	anodisé -01 argent -02 champagne
geëpoxeerd (alleen 4556) -70 zwart	kunststoffbeschildet (nur 4556) -70 schwarz	epoxy plastic coated (4556 only) -70 black	riksanisé (seulement 4556) -70 noir

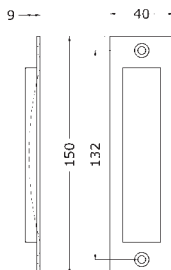
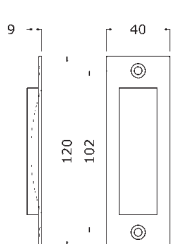

ALUMINIUM SCHUIFDEURKOMMEN

4560



4562

SCHUIFDEURKOM ovaal model aluminium profiel, geanodiseerd	MUSCHELGRIFFE für SCHIEBETÜR Oval Modell Leichtmetall, eloxiert	FLUSH PULL ovaal model extruded aluminium, anodized	POIGNEE CUVETTE pour PORTE COULISSANTE en profilé d'aluminium, anodisé
-01 naturel -02 nieuwzilver	-01 silber -02 neusilber	-01 silver -02 continental	-01 argent -02 champagne

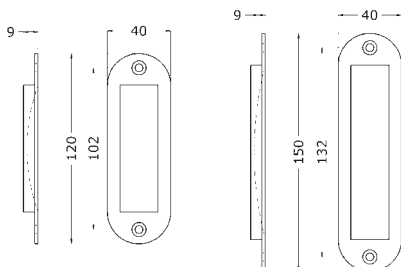

ALUMINIUM DEURDUWERS

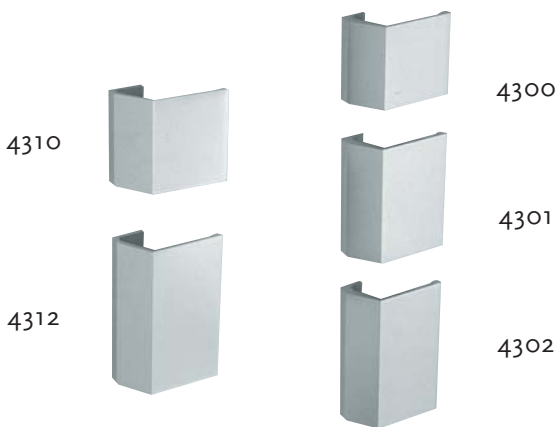

DEURDUWERS van aluminium profiel 90 x 42 mm geanodiseerd	TÜRGRIFFE Leichtmetall 90 x 42 mm eloxiert	PUSH PADS extruded aluminium 90 x 42 mm anodized	BOUTONS DE PORT en profilé d'aluminium 90 x 42 mm anodisé
-01 naturel -02 nieuwzilver	-01 silber -02 neusilber	-01 silver -02 continental	-01 argent -02 champagne
met 2 x tapgat M6 en schroeven M6 x 50 mm 4300 - 4301 - 4302	mit 2 x Bohrungen M6 und Schrauben M6 x 50 mm 4300 - 4301 - 4302	with 2 x M6 threaded holes and fixing bolts M6 x 50 mm 4300 - 4301 - 4302	avec 2 trous taraudés et vis M6 x 50 mm 4300 - 4301 - 4302
met 2 x gat Ø 8,5 mm als stel te gebruiken 4310 - 4312 montageset zie pag. 113	mit 2 x Bohrungen Ø 8,5 mm als Paar zu benützen 4310 - 4312 Montagezubehör siehe Seite 113	with 2 x holes Ø 8,5 mm for back to back pair fixing 4310 - 4312 fixing bolts refer to page 113	avec 2 trous Ø 8,5 mm utiliser par paire 4310 - 4312 accessoires de fixation voir sur page 113

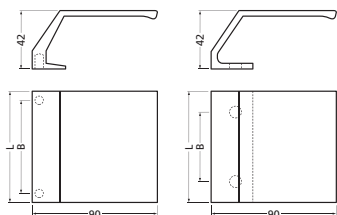

	B	L
4300	67 mm	80 mm
4301	67 mm	120 mm
4302	120 mm	150 mm
4310	50 mm	80 mm
4312	120 mm	150 mm

ALUMINIUM DEURDUWERS



DEURDUWERS van aluminium profiel 113 x 43 mm, geanodiseerd	TÜRGRIFFE Leichtmetall 113 x 43 mm, eloxiert	PUSH PADS extruded aluminium 113 x 43 mm, anodized	BOUTONS DE PORT en profilé d'aluminium 113 x 43 mm, anodisé
-01 naturel -02 nieuwzilver	-01 silber -02 neusilber	-01 silver -02 continental	-01 argent -02 champagne
met 2 x gat Ø 8,5 mm als stel te gebruiken	mit 2 x Bohrungen Ø 8,5 mm als Paar zu benutzen	with 2 x holes Ø 8,5 mm for back to back pair fixing	avec 2 trous Ø 8,5 mm utiliser par paire
montageset zie pag. 113	Montagezubehör siehe Seite 113	fixing bolts refer to page 113	accessoires de fixation voir sur page 113

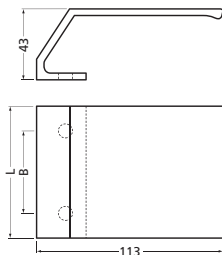

	B	L
4321	120 mm	150 mm
4322	145 mm	175 mm
4325	270 mm	300 mm

ALUMINIUM DEURDUWERS

4330 | 4335



DEURDUWERS "WING"	TÜRGRIFFE "WING"	PUSH PADS "WING"	POIGNEES DE PORT "WING"
van aluminium profiel 136 x 51 mm, geanodiseerd	Leichtmetall 136 x 51 mm, eloxiert	extruded aluminium 136 x 51 mm, anodized	en profilé d'aluminium 136 x 51 mm, anodisé
-01 naturel -02 nieuwzilver -11 mat naturel	-01 silber -02 neusilber -11 matt silber	-01 silver -02 continental -11 matt silver	-01 argent -02 champagne -11 argent mat
met 2 x gat Ø 8,5 mm als stel te gebruiken	mit 2 x Bohrungen Ø 8,5 mm als Paar zu benützen	with 2 x holes Ø 8,5 mm for back to back pair fixing	avec 2 trous Ø 8,5 mm utiliser par paire
montageset zie pag. 113	montagezubehör siehe Seite 113	fixing bolts refer to page 113	accessoires de fixation voir sur page 113

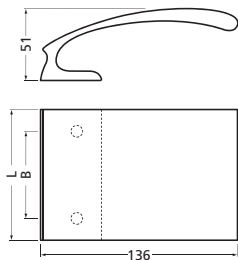

	B	L
4330	60 mm	90 mm
4335	90 mm	120 mm

HOUDERS VOOR DEURDUWERS

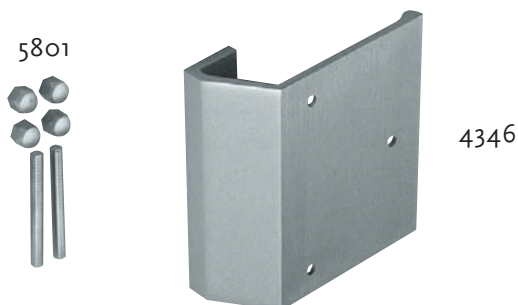

HOUDER VOOR DEURDUWER	HALTERUNG für TÜRGRIF	PUSH PAD BRACKET	SUPPORT POUR POIGNEE
van aluminium profiel 113 x 43 mm, geanodiseerd	Leichtmetall, 113 x 43 mm, eloxiert	extruded aluminium, 113 x 43 mm, anodized	en profilé d'aluminium, 113 x 43 mm, anodisé
-02 nieuwzilver	-02 neusilber	-02 continental	-02 champagne
geschikt voor opbouw van duwplaat naar keuze. met 2 x gat Ø 8,5 mm als stel te gebruiken	zur Anbringung einer Frontplatte nach Wahl. mit 2 x bohrungen Ø 8,5 mm als Paar zu benützen	Suitable for customer tailored push pad. with 2 x holes Ø 8,5 mm for back to back fixing	Prêt à être recouvert par une plaquette au choix. avec 2 trous Ø 8,5 mm utiliser par paire
MONTAGESET	BEFESTIGUNGSSET	FIXING BOLTS	ACCESSOIRES de FIXATION
5801 bestaande uit 2 draadeinden M8 x 70 mm en 4 dopmoeren	5801 bestehend aus 2 Gewindestangen M8 x 70 mm und 4 Hutmuttern	5801 comprises 2 rods M8 x 70 mm and 4 dome headed nuts M8	5801 comprenant 2 tiges filetées M8 x 70 mm et 4 écrous borgnes
-01 naturel -02 nieuwzilver	-01 silber -02 neusilber	-01 silver -02 continental	-01 argent -02 champagne

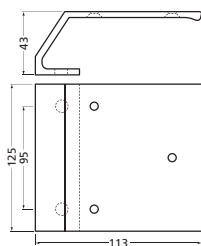

ALUMINIUM DEURDUWERS

4350



DEURDUWERS	TÜRGRIFFE	PUSH PADS	POIGNEES DE PORT
130 x 148 mm van aluminium profiel, geanodiseerd	130 x 148 mm Leichtmetall, eloxiert	130 x 148 mm extruded aluminium, anodized	130 x 148 mm en profilé d'aluminium, anodisé
-01 naturel	-01 silber	-01 silver	-01 argent
met 2 x gat Ø 8,5 mm als stel te gebruiken. Voor de bevestiging kan gebruik gemaakt worden van montage- set 5801 (apart bestel- len). Zie pag. 113	mit 2 x Bohrungen Ø 8,5 mm als Paar zu benützen. Montage- zubehör 5801 muss zusätzlich bestellt werden. Siehe Seite 113	with 2 x holes Ø 8,5 mm for back to back pair fixing. With fixing bolts 5801 , which should be ordered seperately. Refer to page 113	avec 2 trous Ø 8,5 mm utiliser par paire. Accessoires de fixation 5801 à commander séparément. Voir sur page 113

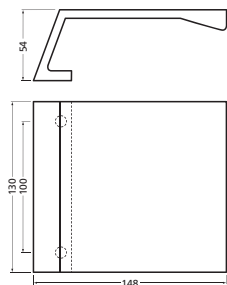

ALUMINIUM DEURBUFFERS



DEURBUFFERS met buffer van zacht kunststof, zwart	TÜRPUFFER mit Puffer von Kunststoff, weich, schwarz	DOORCHECKS with soft plastic buffer, black	ARRÊTS DE PORTE avec butoir en matière synthétique, tendre, noir
<p>gegoten aluminium 4750 - opschroevend -01 naturel -02 nieuwzilver</p>	<p>Leichtmetall 4750-zum Aufschrauben -01 silber -02 neusilber</p>	<p>cast aluminium 4750 - 2 fixing holes -01 silver -02 continental</p>	<p>en fonte d'aluminium 4750 - 2 trous de montage -01 argent -02 champagne</p>
<p>van aluminium profiel onzichtbare bevestiging 4700 - L = 25 mm 4702 - L = 50 mm 4704 - L = 60 mm</p>	<p>Leichtmetall Befestigung verdeckt 4700 - L = 25 mm 4702 - L = 50 mm 4704 - L = 60 mm</p>	<p>extruded aluminium invisible mounting 4700 - L = 25 mm 4702 - L = 50 mm 4704 - L = 60 mm</p>	<p>en profilé d'aluminium fixation cachée 4700 - L = 25 mm 4702 - L = 50 mm 4704 - L = 60 mm</p>
<p>geanodiseerd -01 naturel -02 nieuwzilver -11 mat naturel</p>	<p>eloxiert -01 silber -02 neusilber -11 matt silber</p>	<p>anodized -01 silver -02 continental -11 matt silver</p>	<p>anodisé -01 argent -02 champagne -11 argent mat</p>
<p>LOSSE BUFFER 4709-80 zwart</p>	<p>LOSE PUFFER 4709-80 schwarz</p>	<p>LOOSE BUFFER 4709-80 black</p>	<p>BUTOIR VRAC 4709-80 noir</p>

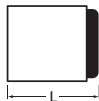
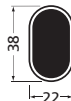
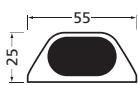
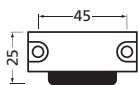

ALUMINIUM DEURBUFFERS

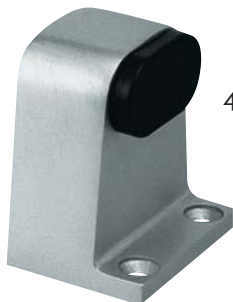

4730



4735

DEURBUFFERS met buffer van zacht kunststof, zwart	TÜRPUFFER mit Puffer von Kunststoff, weich, schwarz	DOORCHECKS with soft plastic buffer, black	ARRÊTS DE PORTE avec boutoir en matière synthétique, tendre, noir
4730 van aluminium profiel opschroevend geanodiseerd -01 naturel -02 nieuwzilver	4730 Leichtmetall zum Aufschrauben eloxiert -01 silber -02 neusilber	4730 extruded aluminium 2 fixing holes anodized -01 silver -02 continental	4730 en profilé d'aluminium 2 trous de montage anodisé -01 argent -02 champagne
4735 van aluminium profiel met tapgat M8 geanodiseerd -11 mat naturel	4735 Leichtmetall Gewindebohrung M8 eloxiert -11 matt silber	4735 extruded aluminium M8 threaded hole anodized -11 matt silver	4735 en profilé d'aluminium trou taraudé M8 anodisé -11 argent mat

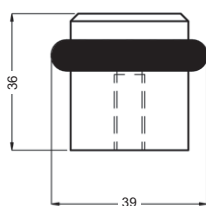
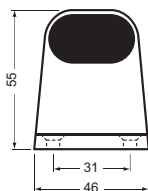

ALUMINIUM DEURBUFFERS



DEURBUFFERS	TÜRPUFFER	DOORCHECKS	ARRÊTS DE PORTE
vloermodel, van aluminium profiel met zacht kunststof ring, ø 60 mm	Bodenmodell, Leichtmetall mit kunststoff Ring, ø 60 mm	floormounting, extruded aluminium with soft plastic ring, ø 60 mm	montage sur le sol, en profilé d'aluminium, anneau matière synthétique, ø 60 mm
4760 met 1x gat ø 5,7 mm	4760 mit 1x Loch ø 5,7 mm	4760 with 1 x hole ø 5,7 mm	4760 avec 1 trou ø 5,7 mm
4765 verhogingsring 15 mm t.b.v. 4760	4765 Erhöhung 15 mm für 4760	4765 elevation ring 15 mm for 4760	4765 anneau 15 mm pour 4760
4760 + 4765 = 4770	4760 + 4765 = 4770	4760 + 4765 = 4770	4760 + 4765 = 4770
geanodiseerd -11 mat naturel	eloxiert -11 matt silber	anodized -11 matt silver	anodisé -11 argent mat

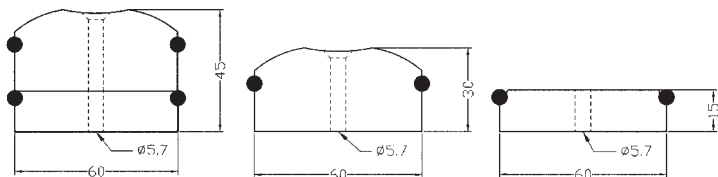



120

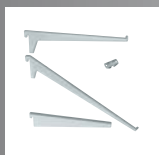

121



124



125

4

WANDRAILSYSTEM
EN DRAGERS

WANDSCHIENE SYSTEM
UND TRÄGER

WALL MOUNTING
RAIL SYSTEM
AND BRACKETS

SYSTÈME CRÉMAILLÈRE
MURALE
ET SUPPORTS

METALUX WANDRAILSSTEEM



5200

5202

5203

5204



2165

WANDRAIL aluminium profiel 18 x 13 mm met sleufperforatie, geanodiseerd	WANDSCHIENE Alu-Profil 18 x 13 mm mit Schlitzlochtung, eloxiert	WALL MOUNTING RAIL SYSTEM slotted aluminum profile 18 x 13 mm, anodized	CREMAILLERE MURALE profil d'aluminium 18 x 13 mm à simple perforation, anodisé
-01 naturel -02 nieuwzilver 5200 - L = 5120 mm 5202 - L = 640 mm 5203 - L = 1280 mm 5204 - L = 1920 mm	-01 silber -02 neusilber 5200 - L = 5120 mm 5202 - L = 640 mm 5203 - L = 1280 mm 5204 - L = 1920 mm	-01 silver -02 continental 5200 - L = 5120 mm 5202 - L = 640 mm 5203 - L = 1280 mm 5204 - L = 1920 mm	-01 argent -02 champagne 5200 - L = 5120 mm 5202 - L = 640 mm 5203 - L = 1280 mm 5204 - L = 1920 mm
EINDSTOP 2165 van kunststof	ENDKAPPE 2165 aus Kunststoff	END CAP 2165 plastic	EMBOUT 2165 en matière plastique
-8o zwart	-8o schwarz	-8o black	-8o noir

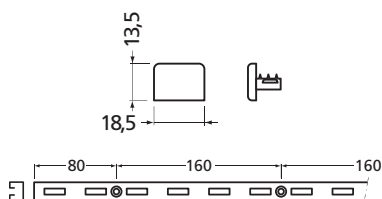

METALUX WANDRAILSysteem

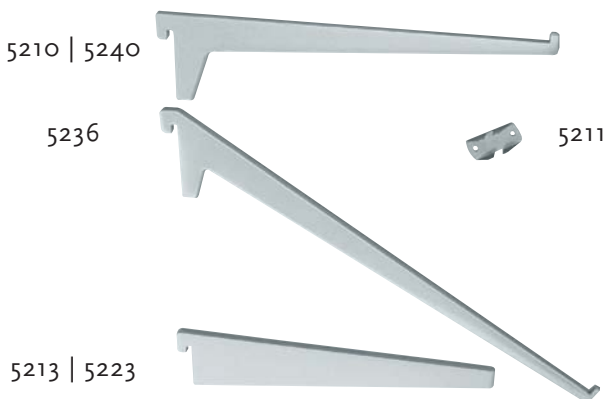

DRAGERS gegoten aluminium, geanodiseerd	TRÄGER Leichtmetall, eloxiert	BRACKETS cast aluminium, anodized	SUPPORTS en fonte d'aluminium, anodisé
-01 naturel -02 nieuwzilver 5210 - L = 100 mm 5215 - L = 150 mm 5220 - L = 200 mm 5225 - L = 250 mm 5230 - L = 300 mm 5235 - L = 350 mm 5240 - L = 400 mm 5236 - L = 360 mm	-01 silber -02 neusilber 5210 - L = 100 mm 5215 - L = 150 mm 5220 - L = 200 mm 5225 - L = 250 mm 5230 - L = 300 mm 5235 - L = 350 mm 5240 - L = 400 mm 5236 - L = 360 mm	-01 silver -02 continental 5210 - L = 100 mm 5215 - L = 150 mm 5220 - L = 200 mm 5225 - L = 250 mm 5230 - L = 300 mm 5235 - L = 350 mm 5240 - L = 400 mm 5236 - L = 360 mm	-01 01 argent -02 champagne 5210 - L = 100 mm 5215 - L = 150 mm 5220 - L = 200 mm 5225 - L = 250 mm 5230 - L = 300 mm 5235 - L = 350 mm 5240 - L = 400 mm 5236 - L = 360 mm
BOEKENSTEUNEN gegoten aluminium, geanodiseerd	BUCHSTÜTZE Leichtmetall, eloxiert	BOOK STOP cast aluminium, anodized	SERRE-LIVRES en fonte d'aluminium, anodisé
-01 naturel -02 nieuwzilver 5213 - L = 130 mm 5223 - L = 230 mm	-01 silber -02 neusilber 5213 - L = 130 mm 5223 - L = 230 mm	-01 silver -02 continental 5213 - L = 130 mm 5223 - L = 230 mm	-01 argent -02 champagne 5213 - L = 130 mm 5223 - L = 230 mm
DWARSLIP 5211 voor het koppelen van planken	VERBINDER 5211	SHELF CONNECTING PIECE 5211	CAVALIER DOUBLE 5211 pour jonction de tablettes
-99 van roestvaststaal	-99 aus Niro-Stahl	-99 stainless steel	-99 en acier inoxydable
STOOTDOPJES 5212 voor glasplaten	AUFLAGE 5212 für Glasplatte	GRUMMET 5212 for use with glass shelves	TETONS 5212 pour plaques de verre
-89 kunststof wit	-89 Kunststoff weiss	-89 plastic white	-89 en matière plas- tique blanc

METALUX WANDRAILSYSTEEM

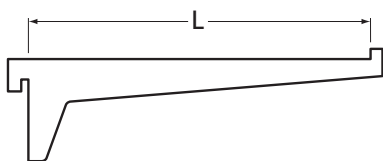

5210 ... 5240

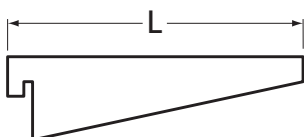

5213 ... 5223

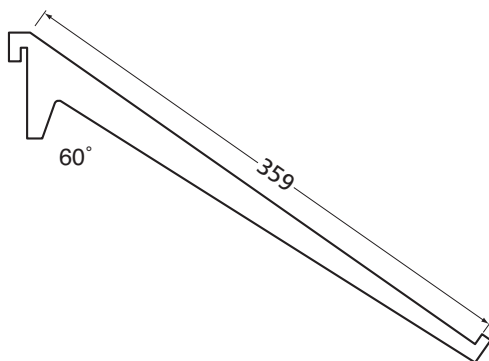

5236

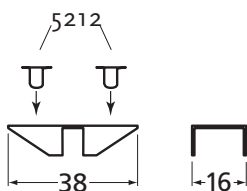

5211



ALUMINIUM BEVESTIGINGSHOEK

5500



BEVESTIGINGSHOEK van aluminium profiel 65 x 65mm, geanodiseerd	MONTAGEWINKEL Leichtmetall 65 x 65mm, eloxiert	CORNER-CLASP extruded aluminium 65 x 65mm, anodized	EQUERRE d'ASSEMBLAGE en profilé d'aluminium 65 x 65mm, anodisé
-11 mat naturel	-11 matt silber	-11 matt silver	-11 argent mat

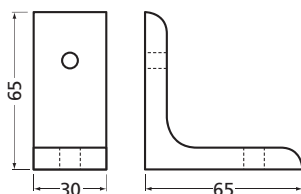

ALUMINIUM CONSOLE

5504 | 5505 | 5506

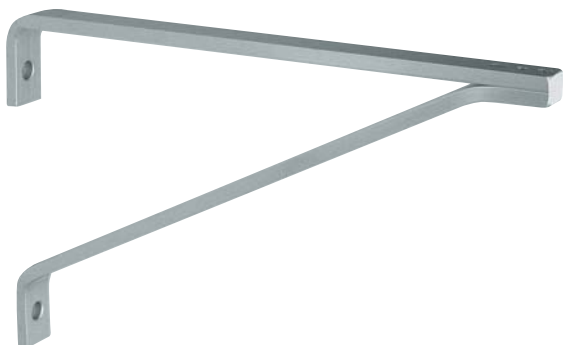

UNIVERSELE CONSOLE	UNIVERSALKONSOLE	BRACKET	CONSOLE
van aluminium profiel 30 x 10 mm, geanodiseerd	Leichtmetall 30 x 10 mm, eloxiert	extruded aluminium 30 x 10 mm, anodized	en profilé d'aluminium 30 x 10 mm, anodisé
-11 mat naturel	-11 matt silber	-11 matt silver	-11 argent mat
5504 - L = 400 mm 5505 - L = 500 mm 5506 - L = 600 mm	5504 - L = 400 mm 5505 - L = 500 mm 5506 - L = 600 mm	5504 - L = 400 mm 5505 - L = 500 mm 5506 - L = 600 mm	5504 - L = 400 mm 5505 - L = 500 mm 5506 - L = 600 mm

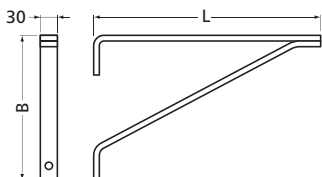

	L	B
5504	400 mm	255 mm
5505	500 mm	325 mm
5506	600 mm	380 mm



128



130



131

5

WANDASBAKKEN
EN AFVALBAKKEN

WANDASCHER
UND ABFALLBEHÄLTER

WALL MOUNTING ASHTRAYS
AND WASTE BINS

CENDRIERS ET POUBELLES
À FIXER SUR PAROI

ALUMINIUM WANDASBAKKEN



3350

3360

3361

WANDASBAK 3350 gegoten aluminium	WANDASCHER 3350 Leichtmetall	ASHTRAY 3350 for wall mounting cast aluminium	CENDRIER 3350 (à fixer sur paroi) en fonte d'aluminium
geanodiseerd -01 naturel	eloxiert -01 silber	anodized -01 silver	anodisé -01 argent
WANDASBAK 3360 en 3361 inhoud 220 cc aluminium	WANDASCHER 3360 und 3361 Inhalt 220 cc Leichtmetall	ASHTRAY 3360 and 3361 for wall mounting content 220 cc aluminium	CENDRIER 3360 et 3361 (à fixer sur paroi) contenance 220 cc aluminium
geanodiseerd -01 naturel	eloxiert -01 silber	anodized -01 silver	anodisé -01 argent

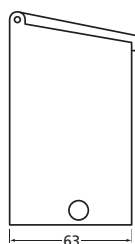
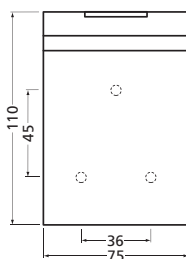
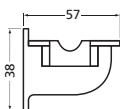
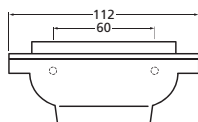



ALUMINIUM WAND-AFVALBAK



3370

WAND-AFVALBAK gegoten aluminium	WAND ABFALL- BEHÄLTER Leichtmetall	WASTE BIN, WALL MOUNTING cast aluminium	POUBELLE À FIXER SUR PAROI en fonte d'aluminium
inhoud 4 liter geëpoxideerd -71 grijs RAL 7036	Inhalt 4 liter kunststoffbeschichtet -71 grau RAL 7036	content 4 liter epoxy plastic coated -71 grey RAL 7036	contenance 4 litre rilsanisé -71 gris RAL 7036

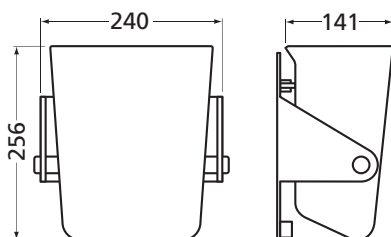

ALUMINIUM WAND-AFVALBAK

3275 | 3280



WAND-AFVALBAK van aluminium profiel, naturel geanodiseerd	WAND ABFALL- BEHÄLTER leichtmetall, silber eloxiert	WASTE BIN, WALL MOUNTING extruded aluminium, silver anodized	POUBELLE À FIXER SUR PAROI en profilé d'aluminium, anodisé argent
eindkappen gegoten en geëpoxeerd blauw RAL 5011	endkappen kunststoff- beschichtet blau RAL 5011	end caps cast aluminium epoxy plastic coated blue RAL 5011	embouts en fonte d'aluminium rilsanisé bleu RAL 5011
3275-753 inhoud 2,5 liter 3280-753 inhoud 3,5 liter	3275-753 Inhalt 2,5 liter 3280-753 Inhalt 3,5 liter	3275-753 content 2,5 liter 3280-753 content 3,5 liter	3275-753 contenance 2,5 liter 3280-753 contenance 3,5 liter

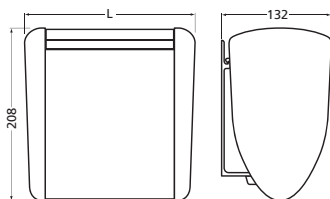

	L
3275	210 mm
3280	280 mm



134...137



138



139



140



141



142



**DOORVALBEVEILIGING
EN DIVERSEN**

VERSCHIEDENES

MISCELLANEOUS

**QUINCAILLERIE
DIVERS**

ALUMINIUM DOORVALBEVEILIGING

GECERTIFICEERD



HERMETA DOORVALBEVEILIGING 'VAST EN ZEKER'

Alle onderdelen van het doorvalbeveiligings-systeem van **Hermeta** zijn vervaardigd van aluminium.

Het systeem biedt veiligheidsoplossingen voor nieuwe en bestaande woning- en utiliteitsbouw.

Het kan worden toegepast voor binnen- en buitengebruik, zowel in de dag montage als op de dag montage.

De aluminium koker kan op standaard lengten of volgens maatspecificatie geleverd worden.

* Voor meer informatie zie onze website.

De doorvalbeveiliging is geschikt om een stootbelasting op te kunnen vangen met een kinetische energie van 0,5 kNm.

Indien de overspanning groter is dan de maximaal toegestane lengte dient u een middensteun toe te passen.

Standaard worden de artikelen geleverd in mat naturel geanodiseerd of in RAL 9010 (wit).

Voor alle situaties geldt dat de meegeleverde montage-, reinigings- en schoonmaakadviezen in acht genomen dienen te worden.

ONDERDELEN VOOR DOORVALBEVEILIGING

GECERTIFICEERD



KOKER VOOR DOORVALBEVEILIGING van aluminium profiel	ROHR ZUR ABSTURZSICHERUNG Leichtmetall	TUBE FOR FALL PREVENTION extruded aluminium	BARRE DE PROTECTION en profilé aluminium
vierkant 28 x 28 x 3,5 m 3650 - L = 6000 mm	vierkant 28 x 28 x 3,5 m 3650 - L = 6000 mm	square 28 x 28 x 3,5 m 3650 - L = 6000 mm	carré 28 x 28 x 3,5 m 3650 - L = 6000 mm
rond/ovaal 28 x 26 x 3 mm 3850 - L = 6000 mm	rund/oval 28 x 26 x 3 mm 3850 - L = 6000 mm	round/oval 28 x 26 x 3 mm 3850 - L = 6000 mm	rond/ovale 28 x 26 x 3 mm 3850 - L = 6000 mm
geanodiseerd -11 mat naturel geëpoxeerd -79 wit	eloxiert -11 matt silber kunststoffbeschichtet -79 weiss	anodized -11 matt silver epoxy plastic coated -79 white	anodisé -11 argent mat rilsanisé -79 blanc
STEUNEN aluminium profiel	TRÄGER Leichtmetall	BRACKETS extruded aluminium	SUPPORTS profilé aluminium
vierkant 3670 - op de dag, links en rechts 3675 - in de dag, links en rechts 3679 - middensteun	vierkant 3670 - befestigung auf die Wand, Links und Rechts 3675 - für seitliche be- festigung, Links und Rechts 3679 - Mittelträger	square 3670 - on the wall mounting, left and right 3675 - side wall mounting, left and right 3679 - middle bracket	carré 3670 - pour fixation murale, gauche et droite 3675 - pour fixation laterale, gauche et droite 3679 - support inter- médiaire
rond/ovaal 3870 - op de dag, links en rechts 3875 - in de dag, links en rechts 3879 - middensteun	rund/oval 3870 - befestigung auf die Wand, Links und Rechts 3875 - für seitliche be- festigung, Links und Rechts 3879 - Mittelträger	round/oval 3870 - on the wall mounting, left and right 3875 - side wall mounting, left and right 3879 - middle bracket	rond/ovale 3870 - pour fixation murale, gauche et droite 3875 - pour fixation laterale, gauche et droite 3879 - support inter- médiaire
geanodiseerd -11 mat naturel geëpoxeerd -79 wit	eloxiert -11 matt silber kunststoffbeschichtet -79 weiss	anodized -11 matt silver epoxy plastic coated -79 white	anodisé -11 argent mat rilsanisé -79 blanc

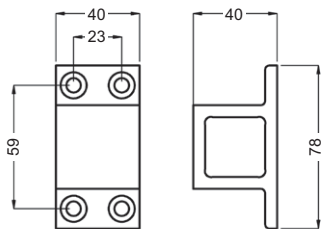

3670 - 3679

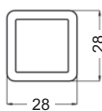

3650

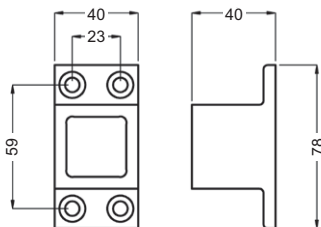

3675

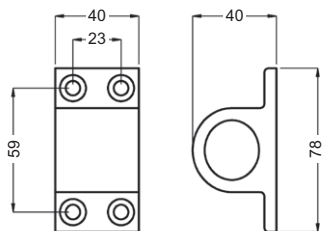

3870 - 3879

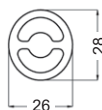

3850

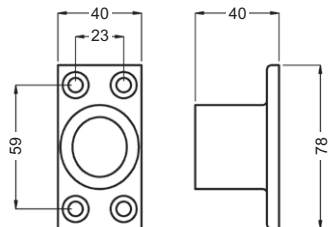

3875



ALUMINIUM KOORDHOUDERS



KOORDHOUDERS gegoten aluminium, geanodiseerd	SCHNURHALTER Leichtmetall, eloxiert	CLEAT HOOKS cast aluminium, anodized	TAQUETS en fonte aluminium, anodisé
-01 naturel	-01 silber	-01 silver	-01 argent
5110 - L = 60 mm 5111 - L = 90 mm 5113 - L = 135 mm	5110 - L = 60 mm 5111 - L = 90 mm 5113 - L = 135 mm	5110 - L = 60 mm 5111 - L = 90 mm 5113 - L = 135 mm	5110 - L = 60 mm 5111 - L = 90 mm 5113 - L = 135 mm

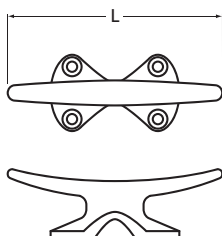

ALUMINIUM AFSLUITBLOKJES

5605



5607



5609



5610



AFSLUITBLOKJES M10 aluminium blank	ABDECKKAPPEN M10 Leichtmetall roh	THREADED ENDS M10 cast aluminium, unfinished	EMBOUTS M10 en fonte d'aluminium, brut
<p>met M10 binnendraad</p> <p>5605-96 voor buis 25 x 25 x 2 mm</p> <p>5607-96 voor buis 30 x 30 x 2 mm</p> <p>5609-96 voor buis 40 x 40 x 2 mm</p> <p>5610-96 voor buis 40 x 40 x 1,5 mm</p>	<p>mit M10 Innengewinde</p> <p>5605-96 für Rohr 25 x 25 x 2 mm</p> <p>5607-96 für Rohr 30 x 30 x 2 mm</p> <p>5609-96 für Rohr 40 x 40 x 2 mm</p> <p>5610-96 für Rohr 40 x 40 x 1,5 mm</p>	<p>with M10 inner thread</p> <p>5605-96 for tube 25 x 25 x 2 mm</p> <p>5607-96 for tube 30 x 30 x 2 mm</p> <p>5609-96 for tube 40 x 40 x 2 mm</p> <p>5610-96 for tube 40 x 40 x 1,5 mm</p>	<p>avec trou taraudé M10</p> <p>5605-96 pour tube 25 x 25 x 2 mm</p> <p>5607-96 pour tube 30 x 30 x 2 mm</p> <p>5609-96 pour tube 40 x 40 x 2 mm</p> <p>5610-96 pour tube 40 x 40 x 1,5 mm</p>

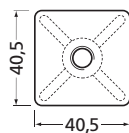
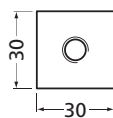
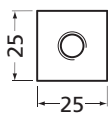

STELVOETEN VOOR AFSLUITBLOKJES



1366

5620

5621

STELVOETEN	STELLFÜSSE	ADJUSTABLE FEET	PIEDS REGLABLES
1366-80 kunststof, zwart met draadeind verzinkt M10 x 30 mm hoogte totaal 45 mm	1366-80 Kunststoff, schwarz mit Gewindestift verzinkt M10 x 30 mm Höhe total 45 mm	1366-80 plastic, black with threaded rod galva- nized M10 x 30 mm total height 45 mm	1366-80 plastique, noir avec tige, fileté galvanisé M10 x 30 mm hauteur totale 45 mm
5620-01 aluminium, naturel geanodiseerd met draadeind verzinkt M10 x 25 mm hoogte totaal 45 mm	5620-01 Leichtmetall, silber eloxiert mit Gewindestift verzinkt M10 x 25 mm Höhe total 45 mm	5620-01 aluminium, silver anodized with threaded rod galvanized M10 x 25 mm total height 45 mm	5620-01 aluminium anodisé argent avec tige, fileté galvanisé M10 x 25 mm hauteur totale 45 mm
5621-01 aluminium, naturel geanodiseerd met draadeind verzinkt M10 x 50 mm hoogte totaal 70 mm	5621-01 Leichtmetall, silber eloxiert mit Gewindestift verzinkt M10 x 50 mm Höhe total 70 mm	5621-01 aluminium, silver anodized with threaded rod galvanized M10 x 50 mm total height 70 mm	5621-01 aluminium anodisé argent avec tige, fileté galvanisé M10 x 50 mm hauteur totale 70 mm

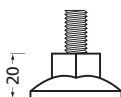
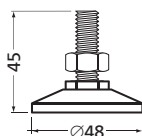
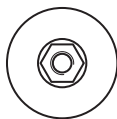

DOPMOEREN



5855



5865



5870

DOPMOER aluminium	HUTMUTTER Leichtmetall	DOME HEADED NUT aluminium	ECROU BORGNE aluminium
5855 - M6 5865 - M8 5870 - M10	5855 - M6 5865 - M8 5870 - M10	5855 - M6 5865 - M8 5870 - M10	5855 - M6 5865 - M8 5870 - M10
geanodiseerd -01 naturel -02 nieuwzilver -18 zwart	eloxiert -01 silber -02 neusilber -18 schwarz	anodized -01 naturel -02 continental -18 black	anodisé -01 argent -02 champagne -18 noir
(5870 alleen in -01)	(5870 nur in -01)	(5870 only in -01)	(5870 seulement en -01)

DIVERSEN

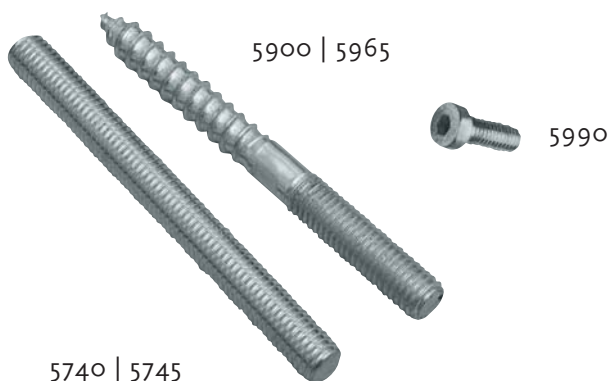

DRAADEIND -99 staal verzinkt	GEWINDESTANGE -99 Stahl, verzinkt	THREADED ROD -99 galvanized steel	TIGE FILETEE -99 en acier galvanisé
5740 M8 x 55 mm	5740 M8 x 55 mm	5740 M8 x 55 mm	5740 M8 x 55 mm
5742 M8 x 70 mm	5742 M8 x 70 mm	5742 M8 x 70 mm	5742 M8 x 70 mm
5745 M8 x 75 mm	5745 M8 x 75 mm	5745 M8 x 75 mm	5745 M8 x 75 mm
STOKSCHROEF -99 staal verzinkt	STOKSCHRAUBE -99 Stahl, verzinkt	THREADED SCREW -99 staal verzinkt	VIS CAPTIVE -99 en acier galvanisé
5900 M4 x 25 mm	5900 M4 x 25 mm	5900 M4 x 25 mm	5900 M4 x 25 mm
5935 M8 x 60 mm	5935 M8 x 60 mm	5935 M8 x 60 mm	5935 M8 x 60 mm
5940 M8 x 70 mm	5940 M8 x 70 mm	5940 M8 x 70 mm	5940 M8 x 70 mm
5945 M8 x 80 mm	5945 M8 x 80 mm	5945 M8 x 80 mm	5945 M8 x 80 mm
5950 M8 x 90 mm	5950 M8 x 90 mm	5950 M8 x 90 mm	5950 M8 x 90 mm
5965 M10 x 120 mm	5965 M10 x 120 mm	5965 M10 x 120 mm	5965 M10 x 120 mm
INBUSBOUT -99 van roestvast staal	ZYLINDERSCHRAUBEN MIT INNENSECHSKANT -99 aus Niro-Stahl	SOCKET HEAD CAP SCREWS -99 stainless steel	VIS à TÊTE CILINDRIQUE -99 en acier inoxydable
5990-99 M8 x 16	5990-99 M8 x 16	5990-99 Pilot recess M8 x 16	5990-99 à six pans creux M8 x 16





148...171



172...191



192...197



198...201



GARDEROBES

GARDEROBEN

CLOAKROOM SYSTEMS

VESTIAIRES

GARDEROBES

INTRODUCTIE GARDEROBES

In deze catalogus vindt u een overzicht van de garderobes uit het assortiment van Hermeta. Alle producten worden door Hermeta zelf geproduceerd in haar moderne, goed geoutilleerde fabriek te Asperen (Gld.). Hierdoor is Hermeta in staat veel zorg aan afwerkingen kwaliteit van haar producten te besteden. Het ontwerpteam van Hermeta houdt zich voortdurend bezig met verbetering van de bestaande garderobesystemen en de ontwikkeling van nieuwe modellen. Het resultaat hiervan is een reeks garderobesystemen die uitblinkt in kwaliteit en functionaliteit. Hermeta garderobes zijn bij uitstek geschikt voor toepassing in kantoren, hotels, restaurants, theaters, scholen, sportinstellingen, enz. Ook in woningen zijn zij uitstekend toe te passen.



green

De Gardelux garderobes voldoen aan alle criteria voor Duurzaam Inkopen van Kantoormeubilair.

GARDELUX 1:
pag. 148 - 171

GARDELUX 2:
pag. 172 - 191

GARDELUX ALLURE:
pag. 192 - 197

GARDELUX DOCK:
pag. 198 - 201

EINLEITUNG GARDEROBEN

In diesem Katalog finden Sie eine Übersicht der Garderoben aus dem Assortiment von Hermeta. Alle Produkte werden von Hermeta selbst in ihrer modernen, gut ausgestatteten Fabrik in Asperen in der niederländischen Provinz Gelderland hergestellt. Hierdurch ist Hermeta in der Lage, der Verarbeitung und Qualität ihrer Produkte die grösste Aufmerksamkeit zu schenken. Das Designer-Team von Hermeta beschäftigt sich hauptsächlich mit der Verbesserung der bestehenden Garderobensysteme und der Entwicklung von neuen Modellen. Hierdurch ist eine Serie von Garderobensysteme entstanden, die sich durch Qualität und Funktionalität auszeichnet. Hermeta Garderoben sind hervorragend für die Anbringung in Büros, Hotels, Restaurants, Schulen, Theatern, Sporthallen, usw. geeignet. Aber auch für Privatwohnungen sind diese Garderoben eine Bereicherung.



green

Die Gardelux Garderoben erfüllen alle Kriterien für Nachhaltig einkaufen von Büromöbel.

GARDELUX 1:
Seite 148 - 171

GARDELUX 2:
Seite 172 - 191

GARDELUX ALLURE:
Seite 192 - 197

GARDELUX DOCK:
Seite 198 - 201

GARDEROBES

INTRODUCTION CLOAKROOM SYSTEMS

This catalogue aims to give you an overview of the wide range of cloakroom systems carried by Hermeta. All products are made by Hermeta itself in its state-of-the-art, well equipped factory in Asperen (Gelderland, the Netherlands), enabling Hermeta to exercise extreme care over the quality and finish of its products. Hermeta's team of designers is continuously engaged in the improvement of the existing cloakroom systems and the development of new models, resulting in a series of cloakroom systems which are unrivalled for quality and functionality. Hermeta's cloakroom systems are pre-eminently suitable for use in offices, hotels, restaurants, theatres, schools, leisure centres, etc. On top of that, they are also highly suitable for use at home.



green

The Gardelux cloakroom systems meets all the criteria for sustainable purchasing of office furniture.

GARDELUX 1:
page 148 - 171

GARDELUX 2:
page 172 - 191

GARDELUX ALLURE:
page 192 - 197

GARDELUX DOCK:
page 198 - 201

INTRODUCTION VESTIAIRES

Ce catalogue présente un aperçu des vestiaires que propose Hermeta dans son assortiment. Tous les produits sont fabriqués par l'entreprise Hermeta même, dans son usine moderne et bien équipée d'Asperen (Gueldre, Pays-Bas). Hermeta est ainsi en mesure de consacrer beaucoup d'attention à la finition et à la qualité de ses produits. L'équipe de conception cherche continuellement à améliorer les vestiaires actuelles et à développer de nouveaux modèles. Le résultat de ces efforts est constitué par une série de vestiaires qui se distinguent par leur qualité et leur aspect fonctionnel. Les vestiaires produites par Hermeta sont destinées par excellence aux bureaux, hôtels, restaurants, théâtres, établissements sportifs, écoles, etc. Il est aussi tout à fait possible de les utiliser dans des habitations.



green

Les vestiaires Gardelux répondent à tous les critères pour marcher durable mobilier de bureau.

GARDELUX 1:
page 148 - 171

GARDELUX 2:
page 172 - 191

GARDELUX ALLURE:
page 192 - 197

GARDELUX DOCK:
page 198 - 201

GARDEROBES | GARDELUX 1

GARDELUX 1

GARDELUX 1 is door haar fraaie, tijdloze vormgeving geschikt voor vele toepassingen. Het modulair opgebouwde garderobesysteem bestaat uit ovale buizen die als dragers voor de haken en als aflegprofiel (voor hoeden) gebruikt worden. In deze catalogus vindt u een groot aantal verschillende typen. Daarnaast zijn er nog talloze mogelijkheden door toepassing van andere haken en/of kledinghangers. Deze combinatiemogelijkheden stellen u in staat om een garderobe te kiezen die optimaal aan uw wensen voldoet. Kenmerken GARDELUX 1: - elke lengte is leverbaar; - 5 typen hoed-/jashaken en 6 typen kledinghangers - materiaal: geanodiseerd aluminium; hart-op-hart afstand van de haken: 15 cm; van de kledinghangers 10 cm; indien gewenst kan men hiervan afwijken.

GARDELUX 1

Das System GARDELUX 1 ist durch seine schöne, zeitlose Formgebung für viele Anwendungsbereiche geeignet. Das aus Bauteilen zusammengestellte Garderobensystem besteht aus ovalen Röhren, die als Halter für die Haken und als Ablageprofil (für Hüte) verwendet werden. In diesem Katalog finden Sie eine Vielzahl von verschiedenen Typen. Darüber hinaus gibt es noch zahllose andere Möglichkeiten, indem andere Haken und/oder andere Kleiderbügel verwendet werden. Durch diese Kombinationsmöglichkeiten sind Sie in der Lage, eine Garderobe zusammenzustellen, die ganz Ihren Wünschen entspricht. Eigenschaften der GARDELUX 1: - in allen Längen lieferbar; - 5 Typen Hut/Mantelhaken und 6 Typen Kleiderbügel, - Material: eloxiertes Aluminium; - der Mittel-abstand zwischen den Haken beträgt 15 cm und zwischen den Kleiderbügel 10 cm; auf Wunsch können diese Abstände geändert werden.

GARDELUX 1

Due to its beautiful and ageless design, the GARDELUX 1 is suitable for a wide range of applications. This modular hat and coat rack system consists of oval tubes, serving both as supports for the hooks and shelf space (for hats). This catalogue will introduce you to a great variety of types. The possibilities created by using other hooks and/or coat hangers are numerous. These combination possibilities enable you to choose a hat and coat rack system which is fine-tuned to your needs. Features GARDELUX 1: - available in any chosen length; - 5 types of hat/coat-hooks and 6 types of coat hangers, - material: anodized aluminium; - centre to centre distance hooks: 15 cm; coat hangers: 10 cm; if so desired, the above can be deviated from.

GARDELUX 1

Par son esthétique et indémodable, GARDELUX 1 se prête à beaucoup d'applications. La vestiaire à construction modulaire comprend des tubes de forme ovale qui sont employés comme supports de crochets et espaces où déposer des chapeaux, par exemple. Vous trouverez dans ce catalogue un grand nombre de modèles différents. L'utilisation d'autres crochets et/ou de cintres permet en outre d'obtenir d'innombrables possibilités. Toutes ces combinaisons possibles vous mettent en mesure de choisir une vestiaire qui réponde de façon optimale à vos désirs. Voici les caractéristiques de GARDELUX 1: - livrable dans toutes les longueurs désirées; - 5 modèles de crochets pour manteaux/chapeaux et 6 modèles de cintres, - matériau: aluminium anodisé; - la distance entre axe des crochets s'élève à 15 cm, celle des cintres à 10 cm; il est possible, si désiré, d'obtenir des mesures différentes.



GARDEROBES | GARDELUX 1

◀58▶



type 1

1010
1030 - 1032
1201

◀58▶



type 2

1010
1040 - 1042
1201

◀135▶



type 3

1010
1050 - 1052
1201

◀195▶



type 4

1010
1070 - 1071 - 1072
1201

GARDEROBES | GARDELUX 1



type 1



type 2



type 3



type 4



De garderobes kunnen op elke gewenste lengte tot 5000 mm geleverd worden.

Die Garderoben können in jeder gewünschten Länge bis 5000 mm geliefert werden.

These coat racks are available in any chosen length till 5000 mm.

Les vestiaires peuvent être livrés dans toutes les longueurs désirées à 5000 mm.

De garderobe in combinatie met eikenhout heeft een maximale lengte van 1500 mm.

Die Garderobe in Kombination mit Eichenholz hat eine maximale Länge von 1500 mm.

The wardrobe in combination with oak wood has a maximum length of 1500 mm.

Le vestiaire en combinaison avec du bois de chêne a une longueur maximale de 1500 mm.

De getoonde typen 1 - 4 zijn voorzien van de terugspringende jashaak 1201.

Die hier abgebildeten Typen 1 - 4 sind mit dem zurückliegenden Mantelhaken 1201 versehen.

The types 1 - 4, as shown on this page, are equipped with receding coat-hooks 1201.

Les modèles 1 - 4 présentés disposent des crochets retraites pour manteaux 1201.

Andere hoed- en jashaken staan op pagina 167.

Andere Hut- und Mantelhaken sind auf Seite 167 abgebildet.

For other hat and coat-hooks please refer to page 167.

D'autres crochets pour manteaux et chapeaux se trouvent à la page 167.

GARDEROBES | GARDELUX 1

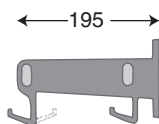

type 5

1010
1080 - 1081 - 1082
1201

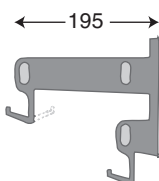

type 6

1010
1090 - 1091 - 1092
1201

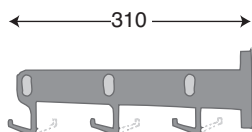

type 7

1010
1110 - 1111 - 1112
1201

GARDEROBES | GARDELUX 1



type 5



type 6



type 7

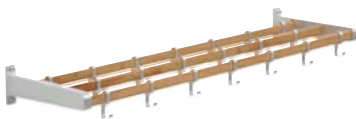

De garderobes kunnen op elke gewenste lengte tot 5000 mm geleverd worden.

Die Garderoben können in jeder gewünschten bis 5000 mm Länge geliefert werden.

These hat and coat racks are available in any chosen length till 5000 mm.

Les vestiaires peuvent être livrés dans toutes les longueurs désirées à 5000 mm.

De garderobe in combinatie met eikenhout heeft een maximale lengte van 1500 mm.

Die Garderobe in Kombination mit Eichenholz hat eine maximale Länge von 1500 mm.

The wardrobe in combination with oak wood has a maximum length of 1500 mm.

Le vestiaire en combinaison avec du bois de chêne a une longueur maximale de 1500 mm.

De getoonde typen 5 - 7 zijn voorzien van de terugspringende jashaak 1201.

Die hier abgebildeten Typen 5 - 7 sind mit dem zurückliegenden Mantelhaken 1201 versehen.

The types 5 - 7, as shown on this page, are equipped with receding coathooks 1201.

Les modèles 5 - 7 présentés disposent des crochets retraités pour manteaux 1201.

Andere hoed- en jas-haken staan op pagina 167.

Andere Hut- und Mantelhaken sind auf Seite 167 abgebildet.

For other hat and coat-hooks please refer to page 167.

D'autres crochets pour manteaux et chapeaux se trouvent à la page 167.

Alle wandgarderobes kunnen ook op een frame gemonteerd worden (pag. 214 - 215).

Alle Wandgarderoben können auch auf einem Rahmen montiert werden (Seite 214 - 215).

All hat and coat racks can also be mounted on a frame (page 214 - 215).

Toutes les vestiaires peuvent être installés sur un cadre (pages 214 - 215).

GARDEROBES | GARDELUX 1

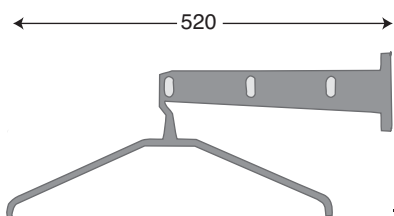

type 7a

1010
1110 - 1111 - 1112
1262

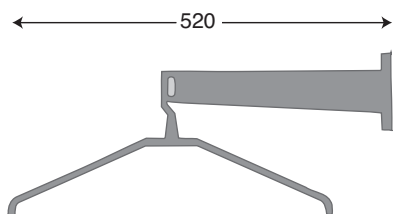

type 8

1010
1100 - 1101 - 1102
1262

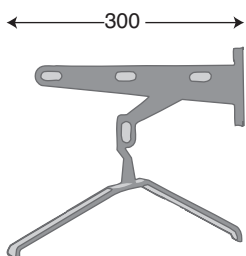

type 9

1010
1130 - 1131 - 1132
1160 - 1161 - 1162
1265

GARDEROBES | GARDELUX 1



type 7a



type 8



type 9



De garderobes kunnen op elke gewenste lengte tot 5000 mm geleverd worden.

Die Garderoben können in jeder gewünschten Länge bis 5000 mm geliefert werden.

These hat and coat racks are available in any chosen length till 5000 mm.

Les vestiaires peuvent être livrés dans toutes les longueurs désirées à 5000 mm.

De garderobe in combinatie met eikenhout heeft een maximale lengte van 1500 mm.

Die Garderobe in Kombination mit Eichenholz hat eine maximale Länge von 1500 mm.

The wardrobe in combination with oak wood has a maximum length of 1500 mm.

Le vestiaire en combinaison avec du bois de chêne a une longueur maximale de 1500 mm.

De getoonde typen 7a en 8 zijn voorzien van de kledinghanger **1262**, en type 9 van **1265** (draaibaar).

Die hier afgebeeldeten Typen 7a und 8 sind mit dem Kleiderbügel **1262** versehen, und Typ 9 mit **1265** (drehbar).

The types 7a and 8, as shown on this page, are equipped with coat hanger **1262**, and type 9 with **1265** (swiveling).

Les modèles 7a et 8 présentés disposent des cintres **1262**, et modèle 9 cintres **1265** (pivotant).

Andere kledinghangers staan op pagina 168 en 169.

Andere Kleiderbügel sind auf Seite 168 und 169 abgebildet.

For other coat hangers please refer to page 168 and 169.

D'autres cintres se trouvent à la page 168 et 169.

Alle wandgarderobes kunnen ook op een frame gemonteerd worden (pag. 214 - 215).

Alle Wandgarderoben können auch auf einem Rahmen montiert werden (Seite 214 - 215).

All hat and coat racks can also be mounted on a frame (page 214 - 215).

Toutes les vestiaires muraux peuvent être installées sur un cadre (page 214 - 215).

GARDEROBES | GARDELUX 1

← 520 →

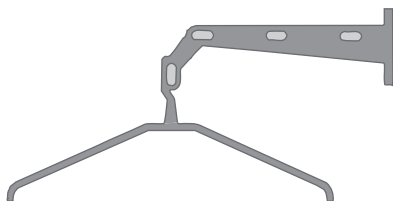

type 10

1010
1130 - 1131 - 1132
1150 - 1151 - 1152
1262

← 520 →

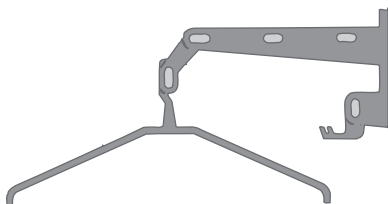

type 13

1010
1140 - 1141 - 1142
1150 - 1151 - 1152
1231
1262

GARDEROBES | GARDELUX 1



type 10

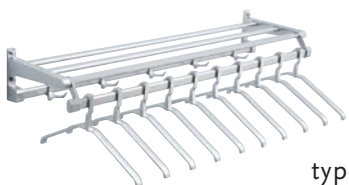

type 13



De garderobes kunnen op elke gewenste lengte tot 5000 mm geleverd worden.

Die Garderoben können in jeder gewünschten Länge bis 5000 mm geliefert werden.

These hat and coat racks are available in any chosen length till 5000 mm.

Les vestiaires peuvent être livrés dans toutes les longueurs désirées à 5000 mm.

De garderobe in combinatie met eikenhout heeft een maximale lengte van 1500 mm.

Die Garderobe in Kombination mit Eichenholz hat eine maximale Länge von 1500 mm.

The wardrobe in combination with oak wood has a maximum length of 1500 mm.

Le vestiaire en combinaison avec du bois de chêne a une longueur maximale de 1500 mm.

De getoonde types 10 en 13 zijn voorzien van dubbele jashaken **1231** en kledinghangers **1262**.

Der hier abgebildete Typen 10 und 13 sind mit dem doppelten Mantelhaken **1231** und dem Kleiderbügel **1262** versehen.

Types 10 and 13, as shown above, are equipped with double coathooks **1231** and coat hangers **1262**.

Les modèles 10 et 13 présentés possèdent des crochets doubles pour manteaux **1231** et des cintres **1262**.

Andere hoed- en jashaken en kledinghangers staan op pagina 167, 168 en 169.

Andere Hut- und Mantelhaken und Kleiderbügel sind auf Seite 167, 168 und 169 abgebildet.

For other hat and coat hooks, as well as coat hangers, please refer to pages 167, 168 and 169.

D'autres crochets pour manteaux et chapeaux et cintres se trouvent aux pages 167, 168 et 169.

Alle wandgarderobes kunnen op een frame gemonteerd worden (pag. 214 - 215).

Alle Wandgarderoben können auch auf einem Rahmen montiert werden (Seite 214 - 215).

All hat and coat racks can also be mounted on a frame (page 214 - 215).

Toutes les vestiaires muraux peuvent être installées sur un cadre (page 214 - 215).

GARDEROBEBUIS | GARDELUX 1

Artikelnr. 1900
Kastroedebuis
zie pagina 32

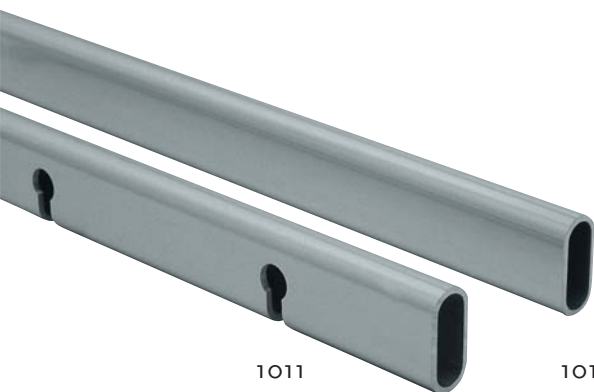

1011

1010

GARDEROBEBUIS (recht ovaal) aluminium profiel	GARDEROBENROHR (flach oval) Alu-Profil	WARDROBE TUBING (flat oval) aluminium profiel	TRINGLE (ovale et aplatie) en profilé d'aluminium
30 x 14 x 2 mm 1010 leverlengte 5000 mm	30 x 14 x 2 mm 1010 Lieferlänge 5000 mm	30 x 14 x 2 mm 1010 standard length 5000 mm	30 x 14 x 2 mm 1010 longueur standard 5000 mm
geanodiseerd -01 naturel -02 nieuwzilver	eloxiert -01 silber -02 neusilber	anodized -01 silber -02 continental	anodisé -01 argent -02 champagne
andere leverlengtes 1015 - L = 1000 mm 1016 - L = 1250 mm 1017 - L = 1500 mm 1018 - L = 2500 mm 1019 - L = 3000 mm	andere Lieferlänge 1015 - L = 1000 mm 1016 - L = 1250 mm 1017 - L = 1500 mm 1018 - L = 2500 mm 1019 - L = 3000 mm	other lengths continental 1015 - L = 1000 mm 1016 - L = 1250 mm 1017 - L = 1500 mm 1018 - L = 2500 mm 1019 - L = 3000 mm	autres longueurs standard 1015 - L = 1000 mm 1016 - L = 1250 mm 1017 - L = 1500 mm 1018 - L = 2500 mm 1019 - L = 3000 mm
Ook leverbaar met enkelzijdige uitstans- ingen h.o.h. 100 mm artikel 1011 (alleen in naturel -01 en nieuwzilver -02) geschikt voor kogelkledinghangers 1260 en 1261.	Auch lieferbar mit ein- seitigen Ausstanzungen Abstand 100 mm 1011 (nur in silber-01 und neusilber-02) geeignet für Kugel-kleiderbügel 1260 und 1261.	Also available with holes on one side only every 100 mm pattern 1011 (only with silver -01 and continental anodized -02) and for use with ball joint coat hangers 1260 and 1261.	Egalement disponible avec boutonnières 100 mm entraxe 1011 (seulement en argent -01 et champagne -02) pour fixation de cintres d'hotel sans crochet 1260 et 1261.

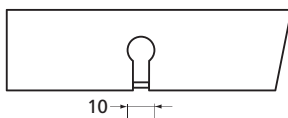
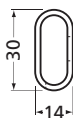
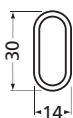

STEUNEN | GARDELUX 1



1170



1175



1180

STEUNEN IN DE DAG gegoten aluminium	WANDLAGER für SEITLICHE BEFESTIGUNG Leichtmetall	END BRACKETS for SIDE WALL MOUNTING cast aluminium	SUPPORTS D'EXTREMITES pour FIXATION LATÉRALE en fonte d'aluminium
geanodiseerd -01 naturel -02 nieuwzilver	eloxiert -01 silber -02 neusilber	anodized -01 silver finish -02 continental	anodisé -01 argent -02 champagne

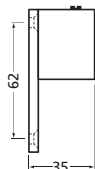
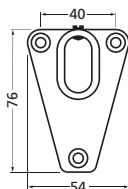
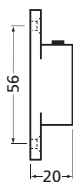
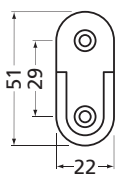

STEUNEN | GARDELUX 1



1040 | 1042

1032

1030

3600

STEUNEN van aluminium profiel	TRÄGER Leichtmetall	BRACKETS extruded aluminium	SUPPORTS en profilé d'aluminium
geanodiseerd -01 naturel -02 nieuwzilver	eloxiert -01 silber -02 neusilber	anodized -01 silver -02 continental	anodisé -01 argent -02 champagne
1030 en 1040 eindsteun 1032 en 1042 middensteun 3600 eindsteun	1030 und 1040 Endträger 1032 und 1042 Mittelträger 3600 Endträger	1030 and 1040 end bracket 1032 and 1042 middle bracket 3600 end bracket	1030 et 1040 supports d'extrémités 1032 et 1042 supports intermédiaires 3600 support d'extrémité

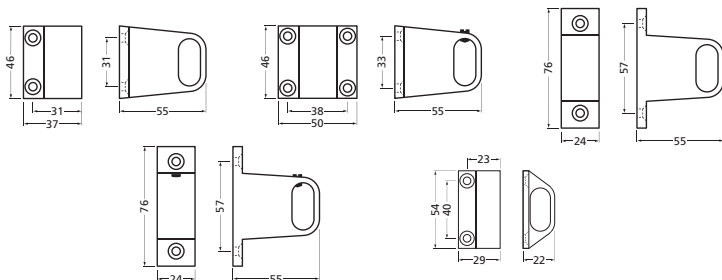

STEUNEN | GARDELUX 1



1194 | 1196

1190 | 1192

STEUNEN voor PLAFONDBEVESTIGING van aluminium profiel	TRÄGER für DECKENBEVESTIGUNG Leichtmetall	BRACKETS for CEILING MOUNTING extruded aluminium	SUPPORTS pour FIXATION au PLAFOND en profilé d'aluminium
geanodiseerd -01 naturel -02 nieuwzilver -11 mat naturel	eloxiert -01 silber -02 neusilber -11 matt silber	anodized -01 silver -02 continental -11 matt silver	anodisé -01 argent -02 champagne -11 argent mat
opschroevend 1190 eindsteun 1192 middensteun met borgschroefje	zum Aufschrauben 1190 Endträger 1192 Mittelträger mit Fixierschraube	2 fixing holes 1190 end bracket 1192 middle bracket with locking screw	2 trous de montage 1190 support d'extrémité 1192 support intermédiaire avec vis de serrage
tapgat M6 1194 eindsteun 1196 middensteun met borgschroefje	Gewindebohrung M6 1194 Endträger 1196 Mittelträger mit Fixierschraube	M6 threaded hole 1194 end bracket 1196 middle bracket with locking screw	trou taraudé M6 1194 support d'extrémité 1196 support intermédiaire avec vis de serrage

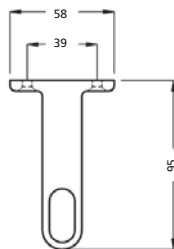
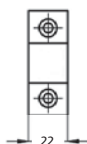
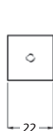

STEUNEN | GARDELUX 1

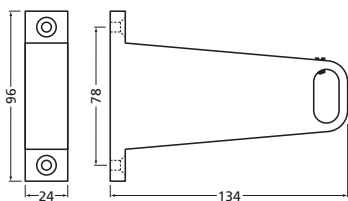

1050 | 1052

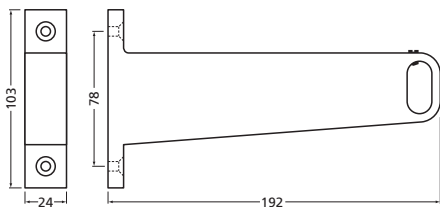

1070 ... 1072

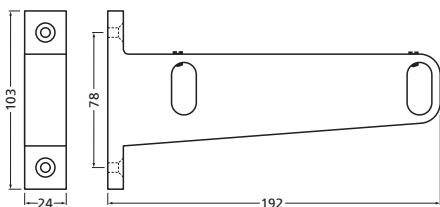

1080 ... 1082

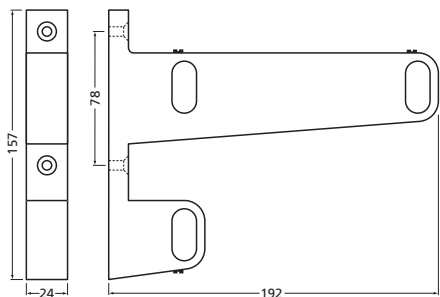

1090 ... 1092

STEUNEN | GARDELUX 1

1050
1052

1070
1071
1072

1080
1081
1082

1090
1091
1092

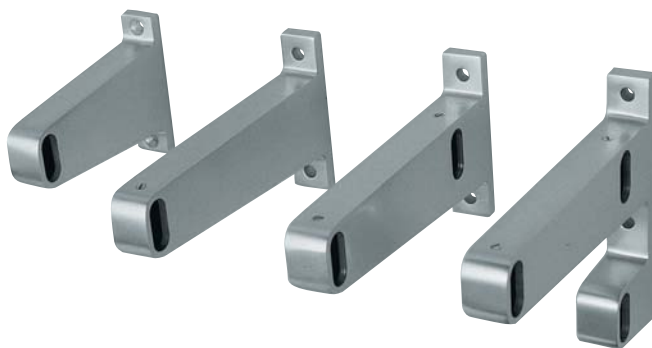

STEUNEN van aluminium profiel	TRÄGER Leichtmetall	BRACKETS extruded aluminium	SUPPORTS en profilé d'aluminium
geanodiseerd -01 naturel -02 nieuwzilver	eloxiert -01 silber -02 neusilber	anodized -01 silver -02 continental	anodisé -01 argent -02 champagne
1050 eindsteun links en rechts 1070, 1080 en 1090 eindsteunen links 1071, 1081 en 1091 eindsteunen rechts 1052, 1072, 1082 en 1092 middensteunen	1050 Endträger links und rechts 1070, 1080 und 1090 Endträger links 1071, 1081 und 1091 Endträger rechts 1052, 1072, 1082 und 1092 Mittelträger	1050 left and right hand bracket 1070, 1080 and 1090 left hand bracket 1071, 1081 and 1091 right hand bracket 1052, 1072, 1082 and 1092 middle bracket	1050 support d'extrémité gauche et droite 1070, 1080 et 1090 support d'extrémité gauche 1071, 1081 et 1091 support d'extrémité droite 1052, 1072, 1082 et 1092 support intermé- diaire

STEUNEN | GARDELUX 1

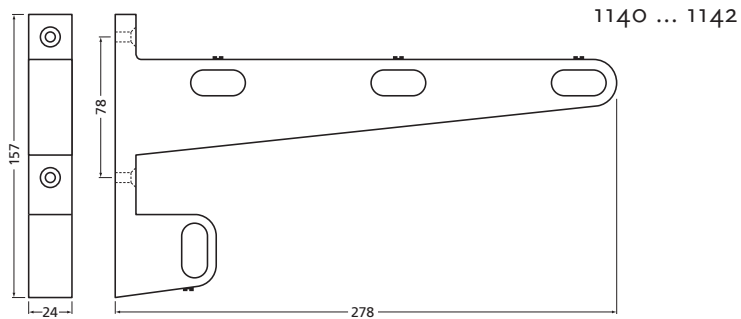
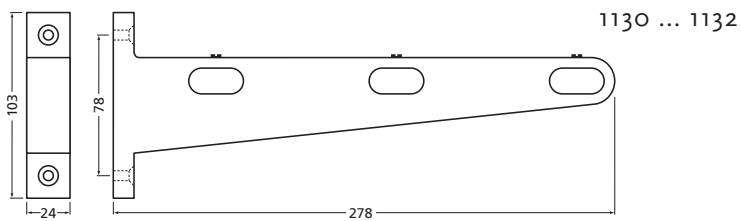
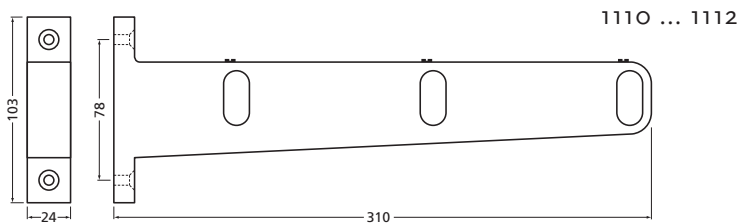
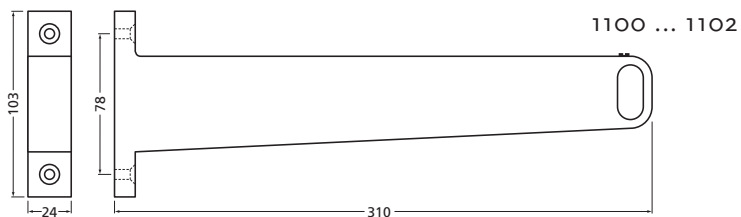

STEUNEN | GARDELUX 1

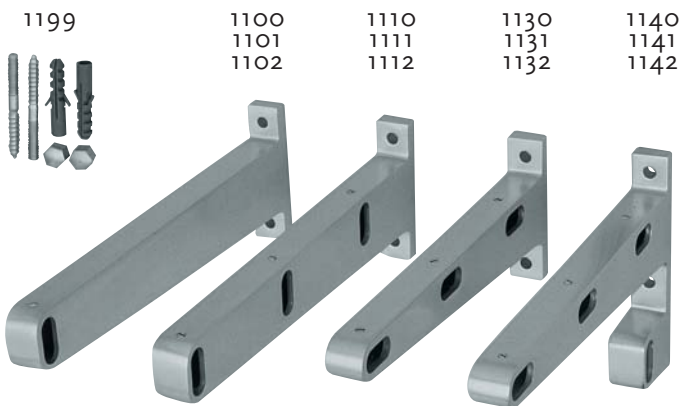

STEUNEN van aluminium profiel	TRÄGER Leichtmetall	BRACKETS extruded aluminium	SUPPORTS en profilé d'aluminium
geanodiseerd -01 naturel -02 nieuwzilver	eloxiert -01 silber -02 neusilber	anodized -01 silver -02 continental	anodisé -01 argent -02 champagne
1100, 1110, 1130 en 1140 eindsteunen links 1101, 1111, 1131 en 1141 eindsteunen rechts 1102, 1112, 1132 en 1142 middensteunen	1100, 1110, 1130 und 1140 Endträger links 1101, 1111, 1131 und 1141 Endträger rechts 1102, 1112, 1132 und 1142 Mittelträger	1100, 1110, 1130 and 1140 left hand bracket 1101, 1111, 1131 and 1141 right hand bracket 1102, 1112, 1132 and 1142 middle bracket	1100, 1110, 1130 and 1140 support d'extrémité gauche 1101, 1111, 1131 and 1141 support d'extrémité droite 1102, 1112, 1132 and 1142 support intermédiaire
MONTAGESET voor STEUNEN	MONTAGEZUBEHÖR für TRÄGER	FIXING KIT for BRACKETS	FIXATIONS pour SUPPORTS
inhoud: 2 pluggen 2 stokschroeven M8 x 70 mm 2 dopmoeren M8	Inhalt: 2 Dübel 2 Stokschrauben M8 x 70 mm 2 Hutmuttern M8	contents: 2 plugs 2 threaded screws M8 x 70 mm 2 M8 domeheaded nuts	composition: 2 chevilles 2 vis captives M8 x 70 mm 2 écrous borgnes M8
1199-01 naturel 1199-02 nieuwzilver	1199-01 silber 1199-02 neusilber	1199-01 silver 1199-02 continental	1199-01 argent 1199-02 champagne

STEUNEN | GARDELUX 1

1150

1151

1152



1160

1161

1162

BEUGELS voor BEVESTIGING aan GARDEROBEBUIS gegoten aluminium	TRÄGER für BEFESTIGUNG an GARDEROBENROHR Leichtmetall	HANGING BRACKETS for FIXING to WARDROBE TUBE cast aluminium	SUPPORTS pour TRINGLE de VESTIAIRE en fonte d'aluminium
geanodiseerd -01 naturel -02 nieuwzilver	eloxiert -01 silber -02 neusilber	anodized -01 silver -02 continental	anodisé -01 argent -02 champagne
1150 en 1160 eindbeugels links 1151 en 1161 eindbeugels rechts 1152 en 1162 middenbeugels	1150 und 1160 Endträger links 1151 und 1161 Endträger rechts 1152 und 1162 Mittelträger	1150 and 1160 left hand bracket 1151 and 1161 right hand bracket 1152 and 1162 middle bracket	1150 et 1160 support d'extrémité gauche 1151 et 1161 support d'extrémité droite 1152 et 1162 support d'intermédiaire

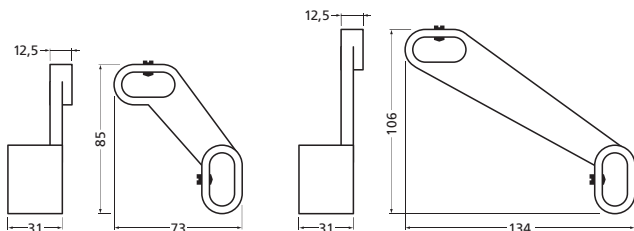

GARDEROBEHAKEN | GARDELUX 1

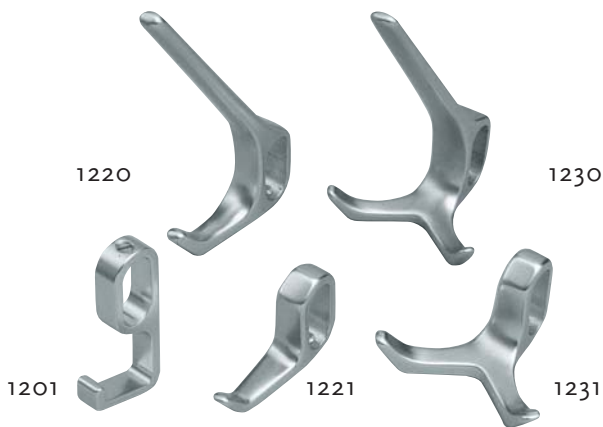

GARDEROBEHAKEN aluminium. Alle haken met borgschroefje	GARDEROBENHAKEN Leichtmetall. Alle Haken mit Fixier-schraube	HAT and COAT HOOKS aluminium. All hooks have locking screw	CROCHETS de VESTIAIRE aluminium. Tous crochets avec vis de serrage
geanodiseerd -01 naturel -02 nieuwzilver	eloxiert -01 silber -02 neusilber	anodized -01 silver -02 continental	anodisé -01 argent -02 champagne

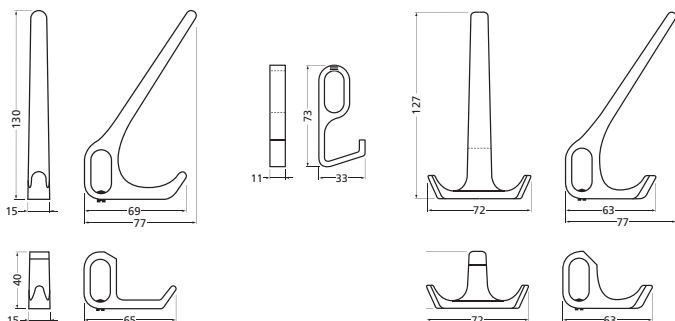

KLEDINGHANGERS | GARDELUX 1

1260 | 1261



KLEDINGHANGERS aluminium	KLEIDERBÜGEL Leichtmetall	COAT HANGERS aluminium	CINTRES aluminium
geanodiseerd -01 naturel -02 nieuwzilver	eloxiert -01 silber -02 neusilber	anodized -01 silver -02 continental	anodisé -01 argent -02 champagne
voor garderobebuis 1011	für Garderobenrohr 1011	to be used with wardrobe tube 1011	pour tringle 1011

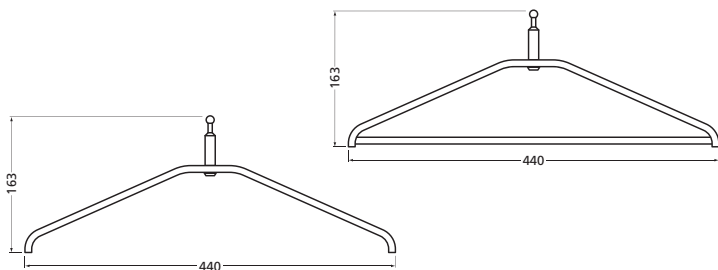

KLEDINGHANGERS | GARDELUX 1

1262 | 1263 | 1265 | 1266



KLEDINGHANGERS aluminium	KLEIDERBÜGEL Leichtmetall	COAT HANGERS aluminium	CINTRES aluminium
geanodiseerd -01 naturel -02 nieuwzilver	eloxiert -01 silber -02 neusilber	anodized -01 silver finish -02 continental finish	anodisé -01 argent -02 champagne
1262 en 1263 zelf- richtend 1265 draaibaar 1266 niet uitneembaar, draaibaar	1262 und 1263 selb- strichtend 1265 drehbar 1266 nicht abnehmbar, drehbar	1262 and 1263 self- aligning 1265 swivelling 1266 non removable, swivelling	1262 et 1263 non pivotant 1265 pivotant 1266 anti-vol, pivotant

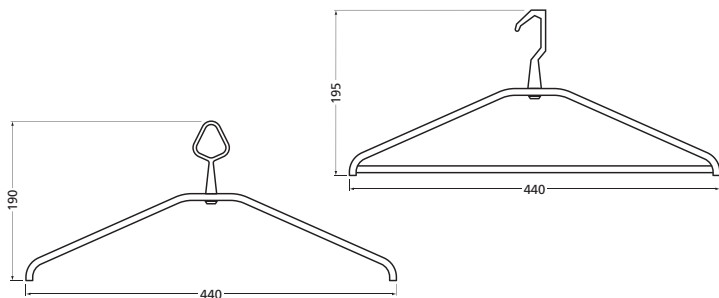

VERBINDINGSSTUKKEN | GARDELUX 1



1270 | 1275 | 1280



1285 | 1290 | 1291

VERBINDINGS- STUKKEN voor GARDEROBEBUIS gegoten aluminium	VERBINDUNG- STÜCKE für GARDEROBENROHR Leichtmetall	CONNECTING PIECES for WARDROBE TUBE cast aluminium	RACCORDS pour TRINGLE de VESTIAIRE en fonte d'aluminium
geanodiseerd -01 naturel -02 nieuwzilver	eloxiert -01 silber -02 neusilber	anodized -01 silver -02 continental	anodisé -01 argent -02 champagne
EINDSTOPS voor GARDEROBEBUIS gegoten aluminium	ENDKAPPEN für GARDEROBENROHR Leichtmetall	END CAPS for WARDROBE TUBE cast aluminium	EMBOUTS pour TRINGLE de VESTIAIRE en fonte d'aluminium
geanodiseerd -01 naturel -02 nieuwzilver	eloxiert -01 silber -02 neusilber	anodized -01 silver -02 continental	anodisé -01 argent -02 champagne

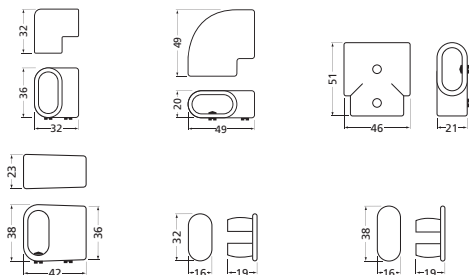



GARDEROBES | GARDELUX 2

GARDELUX 2

Garderobe Gardelux 2 valt op door zijn strakke aluminium lijsten gecombineerd met zwarte haken en zwarte eindstops. Sleutelwoorden voor dit garderobeprogramma zijn functionaliteit en degelijkheid. De getoonde garderobes zijn bijna allemaal leverbaar met de haken en kledinghangers zoals afgebeeld op pag. 184 en 185. De vrijstaande garderobeframes worden veelvuldig toegepast als units, wanneer bevestiging op de wand niet mogelijk of gewenst is. Ook voor Gardelux 2 geldt dat u door de vele mogelijkheden in staat bent een garderobe te kiezen die optimaal voldoet aan uw wensen. Kenmerken Gardelux 2: -elke lengte is leverbaar; -4 typen hoed/jashaken en 3 typen kledinghangers; -profiel en kledinghangers: aluminium naturel of met zwart geanodiseerde haken; - hart-op-hart afstand van de haken: 15 cm; van de kledinghangers 10 cm; indien gewenst kan men hiervan afwijken.

GARDELUX 2

Das Garderobensystem Gardelux 2 fällt durch seine gerade Aluminiumprofile in Kombination mit schwarzen Haken und schwarzen Endkappen auf. Bei diesem Garderobenprogramm dreht sich alles um Funktionalität und Solidität. Die hier gezeigten Garderoben sind nahezu alle mit den auf Seite 184 und 185 abgebildeten Haken und Kleiderbügel lieferbar. Die freistehenden Garderobenrahmen werden oft als Elemente verwendet, wenn eine Befestigung an der Wand nicht möglich oder nicht erwünscht ist. Auch für das System Gardelux 2 gilt, dass Sie durch die vielen Möglichkeiten eine Garderobe zusammenstellen können, die Ihren Wünschen völlig entspricht. Eigenschaften der Gardelux 2: -in allen Längen lieferbar; -4 Typen Hut- und Mantelhaken und 3 Typen Kleiderbügel; -Material der Profile und Kleiderbügel: Aluminium silber matt oder mit schwarz eloxierten Haken; - der Mittelabstand zwischen den Haken beträgt 15 cm und zwischen den Kleiderbügel 10 cm; auf Wunsch können diese Abstände geändert werden.

GARDELUX 2

The Gardelux 2 immediately catches the eye thanks to its austere aluminium frame combined with black hooks and black end caps. The key words for this hat and coat rack programme are functionality and solidity. Nearly all hat and coat racks featured in this catalogue are available with the hooks and coat hangers shown at pages 184 and 185. The freestanding hat and coat stands are frequently used as units, when wall mounting is either impossible or undesired. The many combination possibilities of the Gardelux 2 enable you to choose a hat and coat rack system that is fine-tuned to your needs. Features Gardelux 2: -available in any chosen length; -4 types of hat/coat-hooks and 3 types of coathangers; -frame and coat hangers: naturel aluminium or with black anodized hooks; -centre to centre distance hooks: 15 cm; coat hangers: 10 cm; if so desired, the above can be deviated from.

GARDELUX 2

Vestiaires Gardelux 2 se distingue par son cadre en aluminium rigide combiné à des crochets et des embouts noir. Fonctionnalité et solidité forment les deux mots-clé de cette série. Pratiquement toutes les vestiaires présentées sont livrables avec les crochets et cintres exposés à pages 184 et 185. Les éléments de vestiaire indépendants sont fréquemment utilisés comme unité autonome lorsque l'on ne peut ou veut pas les fixer à la paroi. Egalement dans le cas de la série Gardelux 2, la multitude de combinaisons possibles vous met en mesure de choisir une vestiaires qui réponde de façon optimale à vos désirs. Voici les caractéristique de Gardelux 2: - livrable dans toutes les longueur désirées; - 4 modèles de crochets pour manteaux/chapeaux et 3 modèles de cintres; - le profil et les cintres sont faits d'aluminium naturel ou couleur avec des crochets anodisés noir; la distance entre axe des crochets est de 15 cm, celle des cintres de 10 cm; il est possible, si désiré, d'obtenir des mesures différentes.



GARDEROBES | GARDELUX 2

←52→



type 1

2000
2015
2083

← 150 →



type 2

2000
2081
2091

← 150 →

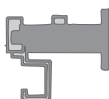

type 3

2000
2005
2083
2091

← 220 →

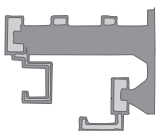

type 6

2000
2005
2081
2083
2092

GARDEROBES | GARDELUX 2



type 1



type 2



type 3



type 6

De garderobes kunnen op elke gewenste lengte tot 5000 mm geleverd worden. De getoonde typen 1, 2, 3 en 6 zijn uitgevoerd met jashaak **2081** en/of **2083**. Andere haken staan op pagina 184.

Die Garderoben können in jeder gewünschten Länge bis 5000 mm geliefert werden. Die hier abgebildeten Typen 1, 2, 3 und 6 sind mit Mantelhaken **2081** und/oder **2083** versehen. Andere Haken sind auf Seite 184 abgebildet.

These hat and coat racks are available in any chosen length till 5000 mm. The types 1, 2, 3 and 6, as shown on this page, are equipped with coathook **2081** and/or **2083**. Other hooks on page 184.

Les vestiaires peuvent être livrés dans toutes les longueurs désirées à 5000 mm. Les modèles 1, 2, 3 et 6 présentés disposent des crochets pour manteaux **2081** et/ou **2083**. D'autres crochets se trouvent à la page 184.

Wandgarderobe type 6 kan ook op een frame gemonteerd worden (pag. 214 - 215).

Wandgarderoben Typ 6 kann auch auf einem Rahmen montiert werden (Seite 214 - 215).

Hat and coat racks type 6 can also be mounted on a frame (page 214 - 215).

Vestiaires modèle 6 peuvent être également installés sur un cadre (page 214 - 215).

GARDEROBES | GARDELUX 2

← 220 →

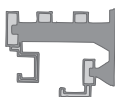

type S

2000
2001
2081
2083
2092
3000

← 308 →

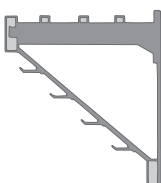

type R

2000
2001
2005
2093
2350

← 525 →

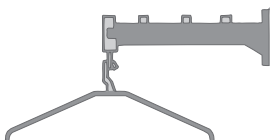

type 9

1262
2001
2005
2093

← 525 →

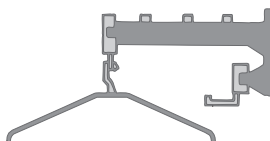

type 10

1262
2000
2001
2005
2081
2094

GARDEROBES | GARDELUX 2



type S

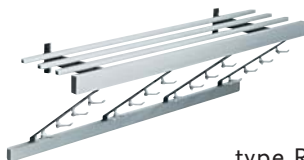

type R

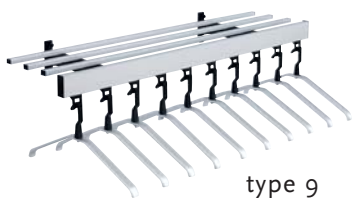

type 9

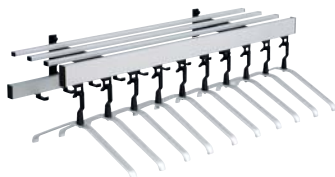

type 10

De garderobes kunnen op elke gewenste lengte tot 5000 mm geleverd worden.

Type S is identiek aan type 6, echter met zwaardere garderobeblijst en legprofielen waardoor bijzonder geschikt voor gebruik in scholen.

Het getoonde type 9 is uitgevoerd met kledinghanger 1262, type 10 met haak 2081 en kledinghanger 1262, type R met hakenstrip 2350. Andere haken en kledinghangers staan op pagina 184 - 185.

Alle wandgarderobes kunnen ook op een frame gemonteerd worden (pagina 214 - 215).

Die Garderoben können in jeder gewünschten Länge bis 5000 mm geliefert werden.

Typ S entspricht Typ 6, ist jedoch mit solideren Hakenleiste und Ablageprofilen versehen, wodurch dieser Typ besonders gut für Schulen geeignet ist.

Der hier abgebildete Typ 9 ist mit Kleiderbügel 1262 versehen. Typ 10 mit Haken 2081 und Kleiderbügel 1262. Typ R ist mit der Hakenleiste 2350 versehen. Andere Haken und Kleiderbügel sind auf Seite 184 - 185 abgebildet.

Alle Wandgarderoben können auch auf einem Rahmen montiert werden (Seite 214 - 215).

These hat and coat racks are available in any chosen length till 5000 mm.

Type S is identical to type 6, however, with bulkier ledges and shelf profiles, as a result of which it is highly suitable for use in schools.

The type 9, as shown on this page, is equipped with coat hanger 1262, type 10 with coat hook 2081 and coat hanger 1262. Type R is equipped with hook strip 2350. For other hooks and coat hangers, please refer to pages 184 - 185.

All hat and coat racks can also be mounted on a frame (page 214 - 215).

Les vestiaires peuvent être livrées dans toutes les longueurs désirées à 5000 mm.

Le modèle S est la même que le modèle 6 à la différence près qu'il possède un espace ou déposer les objets et un cadre plus robustes, ce qui le rend tout particulièrement approprié à un usage dans les écoles.

Le modèle 9 présenté possède des cintres 1262, le modèle 10 des crochets 2081 et des cintres 1262 et le modèle R la bande de crochets 2350. D'autres crochets et cintres se trouvent aux pages 184 - 185.

Les vestiaires muraux peuvent être également installés sur un cadre (pages 214 - 215).

GARDEROBES | GARDELUX 2

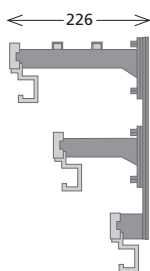

type 12

2000
2005
2015
2083
2091
2096
2354

GARDEROBES | GARDELUX 2

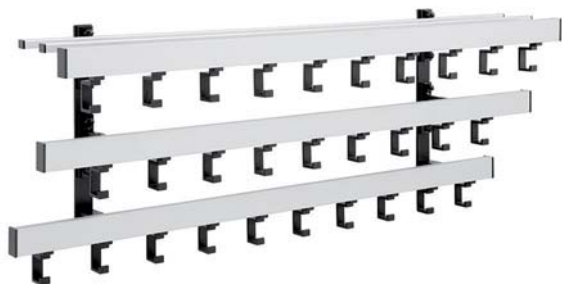

type 12

De garderobes kunnen op elke gewenste lengte tot 5000 mm geleverd worden.

Het getoonde type 12 is uitgevoerd met 3 garderobelijsten en haken **2083**.

Alle wandgarderobes kunnen ook op een frame gemonteerd worden (pagina 214 - 215).

Die Garderoben können in jeder gewünschten Länge bis 5000 mm geliefert werden.

Der hier abgebildete Typ 12 ist mit 3 Hakenleisten und haken **2083** versehen.

Alle Wandgarderoben können auch auf einem Rahmen montiert werden (Seite 214 - 215).

These hat and coat racks are available in any chosen length till 5000 mm.

The type 12, as shown on this page, is equipped with 3 ledges and coat hooks **2083**.

All hat and coat racks can also be mounted on a frame (page 214 - 215).

Les vestiaires sont livrable dans toutes les longueurs jusqu'à 5000 mm.

Le modèle 12 présenté 3 profils de vestiaire et crochets **2083**.

C'est possible de monter les vestiaires sur un cadre (pages 214 - 215).

GARDEROBES | GARDELUX 2



type 10



type R



2265
(zie pag. 224)

Wandgarderobes Gardelux 2 kunnen op een frame gemonteerd worden.	Wandgarderoben Gardelux 2 können auch auf einem Rahmen montiert werden.	Hat and coat racks Gardelux 2 can also be mounted on a frame.	Les vestiaires muraux Gardelux 2 peuvent être installés sur un cadre.
Frames en steunen geëpoxideerd in de kleur:	Rahmen und Träger Kunststoffbeschichtet in den folgenden Farbe:	Frames and brackets epoxy plastic coated in the following colour:	Les cadres et supports sont disponibles dans les couleur suivantes rilsanisé:
-70 zwart RAL 9011	-70 schwarz RAL 9011	-70 black RAL 9011	-70 noir RAL 9011
Zie pagina 214 - 215.	Siehe Seite 214 - 215.	Refer to page 214 - 215.	Voir page 214 - 215.

LIJST- EN LEGPROFIEL | GARDELUX 2

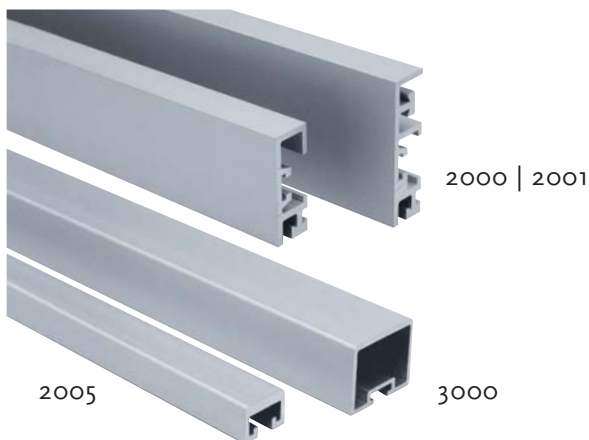

GARDEROBELIJST aluminium profiel	GARDEROBENLEISTE Alu-Profil	FRONTRAIL aluminium profile	PROFIL de VESTIAIRE en profilé d'aluminium
geanodiseerd -11 mat naturel	eloxiert -11 matt silber	anodized -11 matt silver	anodisé -11 argent mat
2000 42 x 16 mm 2001 resp. 56 x 16 mm	2000 42 x 16 mm 2001 bzw. 56 x 16 mm	2000 42 x 16 mm 2001 or 56 x 16 mm	2000 42 x 16 mm 2001 ou 56 x 16 mm
leverlengte 5000 mm	Lieferlänge 5000 mm	standard length 5000 mm	longueur standard 5000 mm
LEGPROFIEL aluminium profiel	ABLAGEPROFIL Alu-Profil	FRONTRAIL aluminium profile	PROFIL PORTE CHAPEAU en profilé d'aluminium
geanodiseerd -11 mat naturel	eloxiert -11 matt silber	anodized -11 matt silver	anodisé -11 argent mat
2005 13 x 18 mm 3000 resp. 25 x 30 mm	2005 13 x 18 mm 3000 bzw. 25 x 30 mm	2005 13 x 18 mm 3000 or 25 x 30 mm	2000 42 x 16 mm 2001 ou 56 x 16 mm
leverlengte 5000 mm	Lieferlänge 5000 mm	standard length 5000 mm	longueur standard 5000 mm

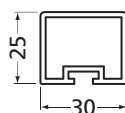
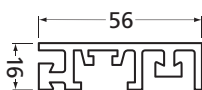
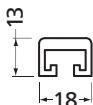
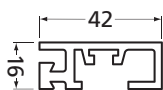

STEUNEN | GARDELUX 2

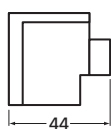
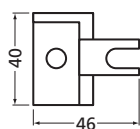

2015

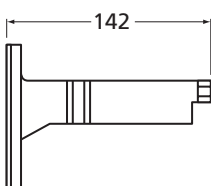
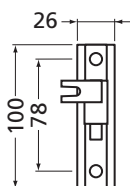

2091

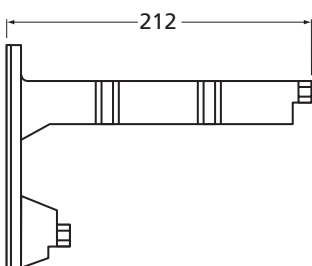
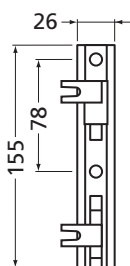

2092

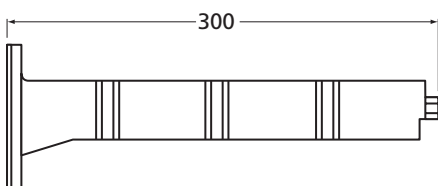
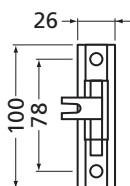

2093

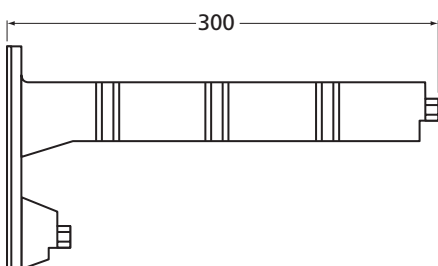
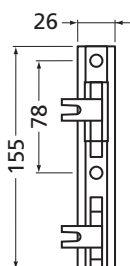

2094

STEUNEN | GARDELUX 2

2094 | 2093 | 2092 | 2091 | 2015



2095



STEUNEN gegoten aluminium	TRÄGER Leichtmetall	BRACKETS cast aluminium	SUPPORTS en fonte d'aluminium
geëpoxeerd -70 zwart	kunststoffbeschichtet -70 schwarz	epoxy plastic coated -70 black	rilsanisé -70 noir
Inclusief bevestigings- materiaal voor montage van garderobelijsten en legprofielen	einschliesslich Befestigungsmaterial für Montage von Garderobenleisten und Ablageprofilen	including front and shelf rails fixings	visserie pour la pose des profilés inclus
MONTAGESET voor STEUNEN	MONTAGEZUBEHÖR für TRÄGER	FIXING KIT for BRACKETS	FIXATIONS pour SUPPORTS
inhoud: 2 pluggen 2 stokschroeven M8 x 70 mm 2 dopmoeren M8	Inhalt: 2 Dübel 2 Stokschrauben M8 x 70 mm 2 Hutmuttern M8	contents: 2 plugs 2 threaded screws M8 x 70 mm 2 M8 domed nuts	composition: 2 chevilles 2 vis captives M8 x 70 mm 2 écrous borgnes M8
2095-18 zwart	2095-18 schwarz	2095-18 black	2095-18 noir

GARDEROBEHAKEN | GARDELUX 2

2081 | 2083 | 2085 | 2082

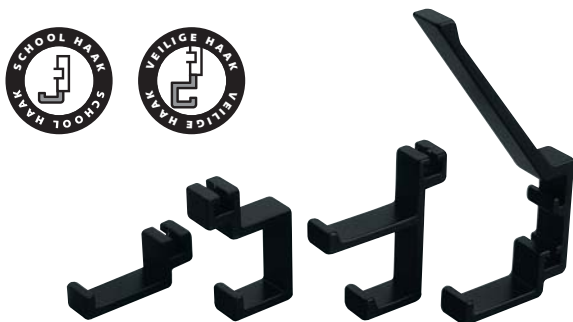

GARDEROBEHAKEN aluminium profiel	GARDEROBENHAKEN Alu-Profil	HAT and COAT HOOKS extruded aluminium	CROCHETS de VESTIAIRE en profilé d'aluminium
geanodiseerd -11 mat naturel -18 zwart	eloxiert -11 matt silber -18 schwarz	anodized -11 matt silver -18 black	anodisé -11 argent mat -18 noir
met borgschroefje	mit Fixierschraube	with locking screw	avec vis de serrage

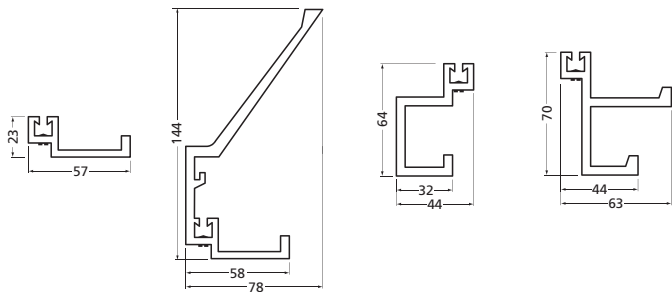

KLEDINGHANGERS | GARDELUX 2

1262 | 1263 | 1264



KLEDINGHANGERS aluminium	KLEIDERBÜGEL Leichtmetall	COAT HANGERS aluminium	CINTRES aluminium
mat geanodiseerd haak zwart: -11 mat naturel	matt eloxiert Haken Schwarz: -11 matt silber	anodized hook black: -11 matt silver	anodisé mat crochet noir: -11 argent mat
1264 niet uitneembaar incl. inhaakoog 2111	1264 nicht abnehmbar einschl. Aufhängeöse 2111	1264 captive hanger incl. hangerhook 2111	1264 cintre anti-vol crochet 2111 inclus

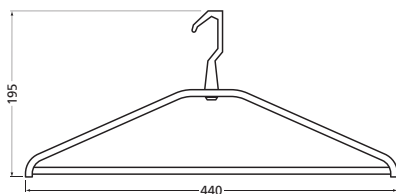

EINDSTOPS | GARDELUX 2



2160

2161

2165

3005

EINDSTOPS	ENDKAPPEN	END CAPS	EMBOUTS
<p>voor garderobelijst: aluminium geanodiseerd -18 zwart</p> <p>2160 voor 2000 2161 voor 2001</p>	<p>für Garderobenleiste: Leichtmetall eloxiert -18 schwarz</p> <p>2160 für 2000 2161 für 2001</p>	<p>for front rail: aluminium anodized -18 black</p> <p>2160 for 2000 2161 for 2001</p>	<p>pour profil de vestiaire: aluminium anodisé -18 noir</p> <p>2160 pour 2000 2161 pour 2001</p>
<p>voor legprofiel: kunststof -80 zwart</p> <p>2165 voor 2005 3005 voor 3000</p>	<p>für Ablageprofil: kunststoff -80 schwarz</p> <p>2165 für 2005 3005 für 3000</p>	<p>for shelf rails: plastic -80 black</p> <p>2165 for 2005 3005 for 3000</p>	<p>pour profils porte-chapeau: plastique -80 noir</p> <p>2165 pour 2005 3005 pour 3000</p>

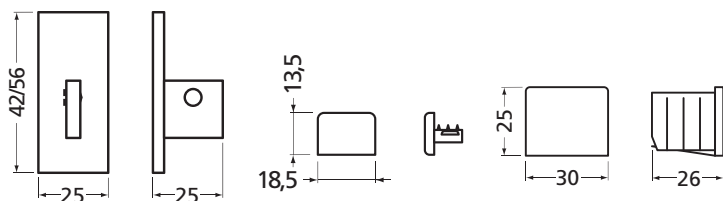

INHAAKOOG | GARDELUX 2



2100

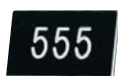

2105



2111

INHAAKOOG kunststof	AUFHÄNGEÖSE Kunststoff	COAT HANGER HOOK plastic	OEILLET pour CINTRE en matière plastique
-80 zwart	-80 schwarz	-80 black	-80 noir
2111 met borgschroefje	2111 mit Fixierschraube	2111 with locking screw	2111 avec vis de serrage
NUMMERPLAATJES kunststof	GARDEROBENMARKE Kunststoff	CLOAK ROOM NUMBERPLATES plastic	NUMEROS de VESTIAIRE en matière plastique
-11 zilver met zwarte cijfers	-11 silber mit schwarzen Zahlen	-11 silver with black numbers	-11 argent avec chiffres noirs
-80 zwart met witte cijfers	-80 schwarz mit weissen Zahlen	-80 black with white numbers	-80 noir avec chiffres blancs
2100 voor uitgifte aan bezoekers 2105 zelfklevend voor bevestiging op garde- robelijst	2100 für Ausgabe an Besucher 2105 (selbstklebend) für Befestigung auf die Garderobenleiste	2100 for handing to visitor 2105 (self adhesive) for fixing to front rail	2100 pour l'utilisateur 2105 (auto-collant) pour fixation sur profil de vestiaire

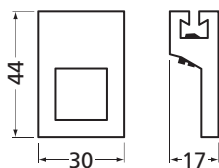

TOEBEHOREN | GARDELUX 2

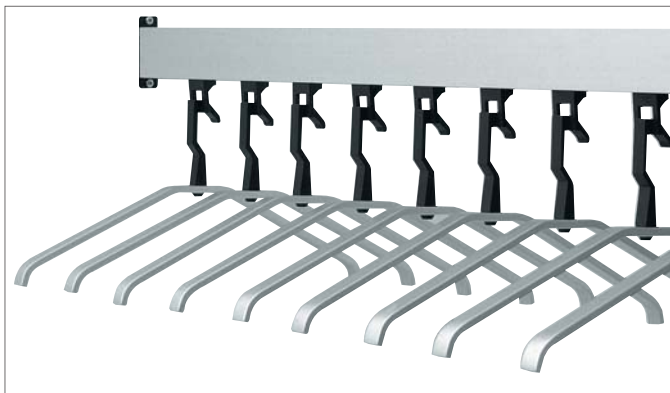

in de dag / zwischen zwei Wänden / between two walls / entre deux parois

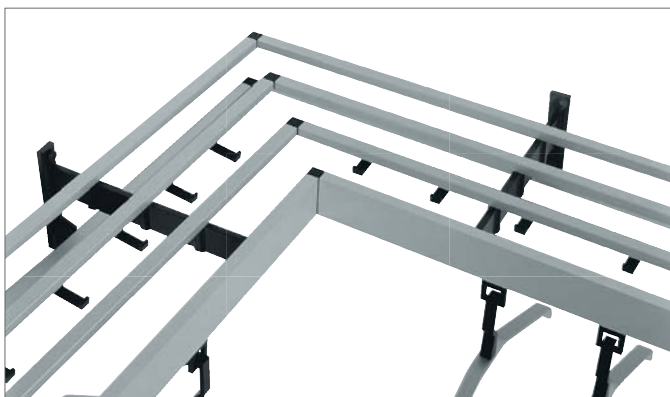

hoekoplossing / Ecklösung / corner solution / installation d'angle



kopafsluiting / Seitenteil / side end cap / fermeture latérale

TOEBEHOREN | GARDELUX 2

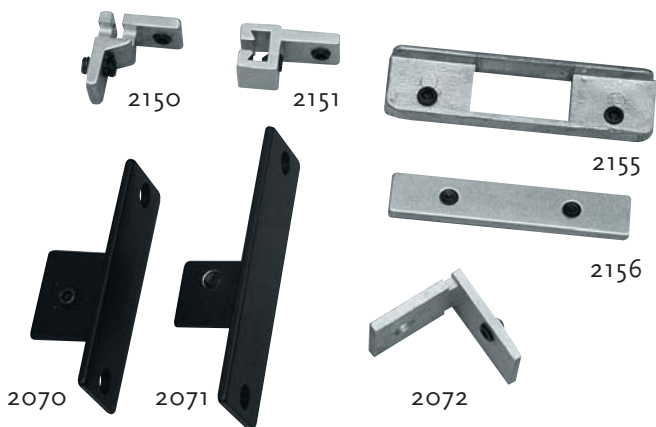

TOEBEHOREN aluminium	ZUBEHÖR Leichtmetall	ACCESSORIES aluminium	ACCESSORIES aluminium
<p>2150-96 T-verbinding garderobelijst 2000 legprofiel 2005</p> <p>2151-96 T-verbinding garderobelijst 2001 legprofiel 2005</p> <p>2155-96 koppeling garderobelijst 2000 en 2001</p> <p>2156-96 koppeling legprofiel 2005</p> <p>2070-18 steun i.d. dag voor garderobelijst 2000</p> <p>2071-18 steun i.d. dag voor garderobelijst 2001</p> <p>2072-11 muurbevestiging voor garderobelijst 2000</p>	<p>2150-96 T-Verbinder für Garderobenleiste 2000 Ablageprofil 2005</p> <p>2151-96 T-Verbinder für Garderobenleiste 2001 Ablageprofil 2005</p> <p>2155-96 Kupplung für Garderobenleiste 2000 und 2001</p> <p>2156-96 Kupplung für Ablageprofil 2005</p> <p>2070-18 Träger für seitliche Befestigung der Leiste 2000</p> <p>2071-18 Träger für seitliche Befestigung der Leiste 2001</p> <p>2072-11 Träger für Wandbefestigung der Leiste 2000</p>	<p>2150-96 T-connector for front rail 2000 and shelf rail 2005</p> <p>2151-96 T-connector for front rail 2001 and shelf rail 2005</p> <p>2155-96 coupling for front rail 2000 and 2001</p> <p>2156-96 coupling for shelf rail 2005</p> <p>2070-18 end bracket for fixing rail 2000 to side wall</p> <p>2071-18 end bracket for fixing rail 2001 to side wall</p> <p>2072-11 support for back wall fixing of 2000 rail</p>	<p>2150-96 raccord en T pour profilés 2000 avec 2005</p> <p>2151-96 raccord en T pour profilés 2001 avec 2005</p> <p>2155-96 raccord pour profilés 2000 et 2001</p> <p>2156-96 raccord pour profilés 2005</p> <p>2070-18 support pour fixation latérale du profilé 2000</p> <p>2071-18 support pour fixation latérale du profilé 2001</p> <p>2072-11 support pour fixation à la paroi du profilé 2000</p>

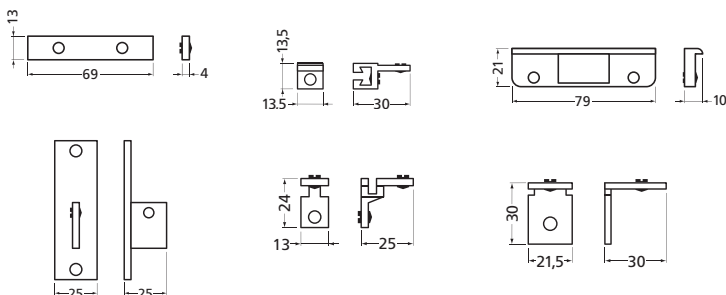

VERBINDINGSSTUKKEN | GARDELUX 2



2130

2131

2140

2141



2135

2136

2145

VERBINDINGS-STUKKEN voor GARDEROBELIJST en LEGPROFIEL aluminium	VERBINDUNGS-STÜCKE für GARDE-ROBENLEISTE und ABLAGEPROFIL Leichtmetall	CONNECTION PIECES for FRONT and SHELF RAIL aluminium	RACCORDS pour PROFILS de VESTIAIRE et PORTE-CHAPEAU aluminium
geëpoxeerd -70 zwart	kunststoffbeschichtet -70 schwarz	epoxy plastic coated -70 black	rilsanisé -70 noir

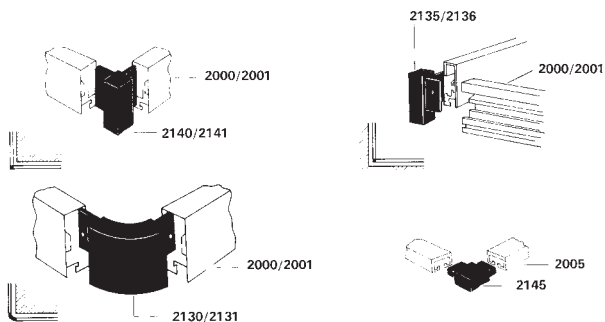
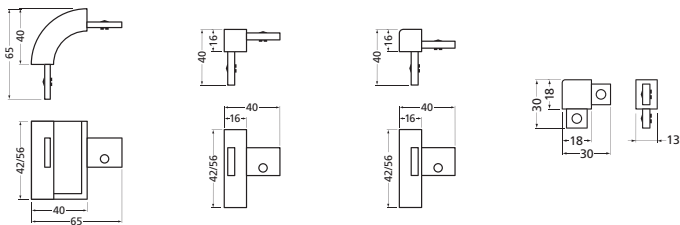

HAKENSTRIP | GARDELUX 2R



HAKENSTRIP	HAKENLEISTE	COAT HOOK STRIP	BARRE PORTE-CROCHETS
2350-21 zwart geëpoexerd 25 x 5 mm stalen strip met 4 naturel geanodiseerde aluminium dubbele jashaken.	2350-21 Leiste aus Stahlblech 25 x 5 mm, schwarz kunststoffbeschichtet. 4 silber eloxierte Aluminium Doppelhaken.	2350-21 Steel strip 25 x 5 mm, black epoxy plastic coated, with 4 silver anodized aluminium double coat hooks.	2350-21 en acier 25 x 5 mm rilsanisé noir, avec 4 crochets doubles en fonte d'aluminium anodisé argent.
ACHERTERPLAAT voor STEUN	BEFESTIGUNGSWINKEL	BACKPLATE for fixing BOTTOM RAIL	SUPPORT
2351-70 staal zwart geëpoexerd, inclusief bevest. materiaal voor het monteren van sierlijst 2000 tegen standaard.	2351-70 Stahl, schwarz kunststoffbeschichtet, einschl. Befestigungsmaterial für Montage einer Zierleiste 2000 auf Garderobenrahmen.	2351-70 Steel black epoxy plastic coated, complete with screws and nuts. Only for use when fixing rail 2000 on a frame.	2351-70 en acier, rilsanisé noir. Support pour profilé 2000 employé en cas de montage de vestiaire sur un cadre.
STEUN voor GARDEROBELIJST	STÜTZE für GARDEROBENLEISTE	BRACKET for BOTTOM RAIL	SUPPORT pour PROFIL DE VESTIAIRE
2352-18 van aluminium profiel, zwart geanodiseerd, met borschroefje. Alleen te gebruiken bij wandmontage.	2352-18 aus Alu-Profil, schwarz eloxiert, mit Fixierschraube. Nur zu verwenden bei Wandmontage.	2352-18 Made of extruded aluminium, black anodized, with locking screw. Only for use when fixing to walls.	2352-18 en profilé d'aluminium, noir. Vis de serrage inclus. Seulement pour fixation du vestiaire contre le pari.

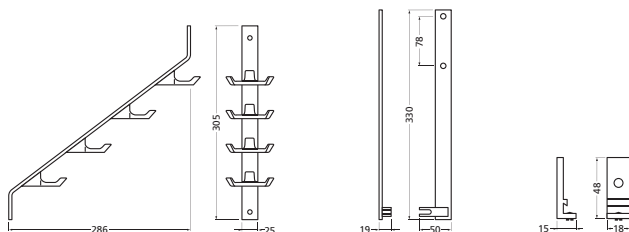

GARDELUX ALLURE

GARDELUX ALLURE

Door de fraaie en eigentijdse vormgeving is GARDELUX ALLURE een buitengewoon representatief garderobesysteem. Opvallend en functioneel in elke ontvangstruimte waar stijl op prijs gesteld wordt. Dit systeem bewijst dat vormgeving uitstekend samen kan gaan met doelmatigheid. Het is bovendien moeiteloos aan te passen aan een specifieke projectwens en bijzonder praktisch in gebruik. De gunstige prijsstelling en de eenvoudige montage maakt het systeem ideaal voor projectinrichting, maar ook bij u thuis kan GARDELUX ALLURE een stijlvol element aan uw ontvangstruimte toevoegen. Op maat en in stijl voor elke toepassing. De modulaire opbouw van GARDELUX ALLURE maakt het systeem geschikt voor elke toepassing. Van een elegant profiel met jashaken of een ruime kapstok met hoedenplank tot een complete garderobe voor een bedrijf of openbare gelegenheid. De kenmerkende ellips-vormige profielen geven Gardelux Allure een modern karakter. Stijlvol door de combinatie van natuurlijk aluminium met zwart kunststof en eigentijdse kleuraccenten. De gardero-bes zijn op bijna elke gewenste lengte aan te passen en leverbaar in 5 verschillende kleurstellingen.

GARDELUX ALLURE

Aufgrund seines ansprechenden und modernen Designs ist GARDELUX ALLURE ein außerordentlich repräsentatives Garderobensystem. Auffallend und funktionell in jedem Empfangsraum, in dem man Stil schätzt. Dieses System beweist, daß sich Design und Zweckmäßigkeit ausgezeichnet miteinander verbinden lassen. Daneben läßt es sich mühelos an alle spezifischen Projektwünsche anpassen und ist besonders praktisch im Gebrauch. Aufgrund des günstigen Preises und der einfachen Montage ist das System ideal für alle Arten von Projekt-einrichtungen. Aber auch bei Ihnen zu Hause kann GARDELUX ALLURE Ihrem Empfangsraum stilvolle Akzente verleihen. Maß- und stilgerecht für jeden Verwendungszweck. Durch die Modulbauweise von Gardelux Allure ist das System für alle erdenklichen Einsatzmöglichkeiten geeignet. Vom eleganten Profil mit Mantelhaken oder einer großzügigen Garderobe mit Hutablage bis zur kompletten Garderobe eines Unternehmens oder einer öffentlichen Einrichtung. Die charakteristischen ellipsenförmigen Profile verleihen GARDELUX ALLURE ein modernes Ansehen. Stilvoll durch die Kombination von natürlichem Aluminium mit schwarzem Kunststoff und modernen Farbakkzenten. Die Garderoben lassen sich auf praktisch jede gewünschte Länge anpassen und sind in 5 verschiedenen Farbstellungen lieferbar.

GARDELUX ALLURE

Its attractive and contemporary design makes GARDELUX ALLURE an extremely presentable wardrobe system. It fits eye-catchingly and conveniently into any reception area in which great store is set by style. This system proves that design and functionality can go together perfectly. It is also extremely easy to adapt to specific project requirements and has many practical applications. The attractive price and the simplicity of assembly make the system ideal for project design, but GARDELUX ALLURE can also add an element of style to your reception area at home. Tailor-made and styled for every application. The modular structure of GARDELUX ALLURE makes the system suitable for any application, ranging from an elegant jacket hooks fixture or a spacious coat rack with hat shelf to a complete wardrobe for a company or public building. The characteristic elliptical sections give GARDELUX ALLURE its contemporary character and the combination of natural aluminium with black plastic and contemporary colour accents make this an elegant product. The wardrobes can be adapted to almost any length and can be supplied in 5 different colour schemes.

GARDELUX ALLURE

Grâce à un design moderne et séduisant, GARDELUX ALLURE est un système de portemanteaux particulièrement esthétique. Original et fonctionnel, il trouve sa place dans chaque lieu d'accueil où l'élégance et le style sont appréciés. Ce système démontre qu'il est possible d'allier parfaitement design et commodité. Extrêmement pratique, il peut être aisément adapté pour répondre à des désirs spécifiques. Son prix avantageux et son montage simple en font un système idéal pour des agencements de projets. Mais chez vous également, GARDELUX ALLURE peut ajouter un élément élégant à votre entrée. Sur mesure et de bon goût, il convient à de multiples applications. L'assemblage modulaire de GARDELUX ALLURE permet l'intégration de ce système aux situations les plus diverses. Du profilé élégant avec crochets ou du large portemanteau avec porte-chapeaux au vestiaire complet pour entreprise ou lieu public. Les profilés aux formes elliptiques caractéristiques donnent un caractère moderne à GARDELUX ALLURE, dont l'élégance est renforcée par la combinaison d'aluminium naturel et de matière synthétique noire, associés à des touches de couleurs actuelles. Les portemanteaux peuvent être réalisés dans pratiquement n'importe quelle longueur et sont disponibles en 5 harmonies de couleurs différentes.



GARDEROBES | GARDELUX ALLURE

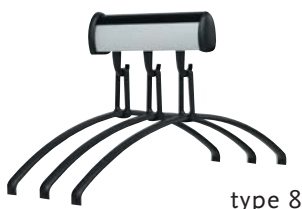

met 1, 2 of 3 kledinghangers

type 8



type 11



type 8a



type 11a

type 8
wandkapstok met 1, 2 of 3 kledinghangers.

Typ 8
Wandgarderobe mit 1, 2, oder 3 Kleiderbügel.

type 8
coat rack with 1, 2 or 3 coat hangers.

modèle 8
patère avec 1, 2 or 3 cintres.

type 8a
wandkapstok met 6 jashaken.

Typ 8A
Wandgarderobe mit 6 Mantelhaken.

type 8a
coat rack with 6 coat hooks.

modèle 8a
patère avec 6 crochets.

type 11
wandkapstok, magneet, met 2 kledinghangers voor plaatsing tegen stalen kasten/wanden.

Typ 11
Wandgarderobe, Magnet, mit 2 Kleiderbügel, Platzierung an Stahlschränke oder Wände.

type 11
coat rack, magnetic, with 2 coat hangers, to put against steel cupboard or wall.

modèle 11
patère magnétique avec 2 cintres, pour placer au armoire acier ou au mur acier.

type 11a
wandkapstok, magneet, met 4 jashaken.

Typ 11a
Wandgarderobe, Magnet, mit 4 Mantelhaken.

type 11a
coat rack, magnetic, with 4 coat hooks.

modèle 11a
patère magnétique avec 4 crochets.

Van aluminium profiel, mat naturel geanodiseerd. Haken en/of kledinghangers en eindkappen kunststof: zwart.
Leverbaar in 5 verschillende accentkleuren.

Alu-profil, silber matt eloxiert. Haken und/oder kleiderbügel und Endkappen Kunststoff: schwarz.
In 5 verschiedenen Akzentfarben lieferbar.

Extruded aluminium, silver matt anodized. Hooks and/or coat hangers and endcaps plastic: black.
Can be supplied in 5 different accent colours.

En aluminium profiel, anodisé mat argent. Crochets et/or cintres et embouts en matière plastique: noir.
Sont disponibles en 5 couleurs de complémentaires.

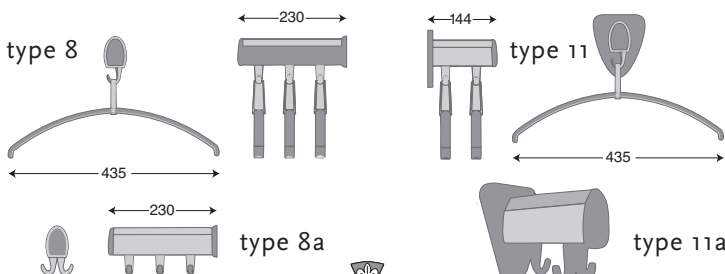

GARDEROBES | GARDELUX ALLURE



type 1



type 3



type 6

Wandgarderobes GARDELUX ALLURE typen 1, 3 en 6 kunnen geleverd worden tot een lengte van 5000 mm, (hout tot 3000 mm) met naar keuze 8 of 10 haken per meter.

Van aluminium profiel, mat naturel geanodiseerd. Haken en/of kledinghangers en eindhaken kunststof: zwart. Leverbaar in 5 verschillende accentkleuren.

Wandgarderoben GARDELUX ALLURE Typen 1, 3 en 6 können geliefert werden bis 5000 mm Länge, (holz bis 3000 mm), und mit 8 oder 10 Haken pro Meter.

Alu-profil, silber matt eloxiert. Haken und/oder kleiderbügel und Endkappen Kunststoff: schwarz. In 5 verschiedenen Akzentfarben lieferbar.

Hat and coat racks GARDELUX ALLURE types 1, 3 and 6 are available in a length till 5000 mm, (wood till 3000 mm) and with 8 or 10 coat hooks per meter.

Extruded aluminium, silver matt anodized. Hooks and/or coat hangers and endcaps plastic: black. Can be supplied in 5 different accent colours.

Les vestiaires GARDELUX ALLURE modèles 1, 3 et 6 peuvent être livrés dans les longueurs à 5000 mm, (bois à 3000 mm) et avec 8 ou 10 crochets par mètre.

En aluminium profilé, anodisé mat argent. Crochets et/ou cintres et embouts en matière plastique: noir. Sont disponibles en 5 couleurs de complémentaires.

type 1



type 3

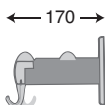

type 6

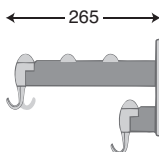

GARDEROBES | GARDELUX ALLURE



type 9



type 10

GARDELUX ALLURE

type 9

enkele garderobebuis met kledinghangers en hoedenplank. Lengte tot 5000 mm (hout tot 3000 mm). 8 of 10 kledinghangers per meter.

type 10

dubbele garderobebuis met haken, kledinghangers en hoedenplank. Lengte tot 5000 mm (hout tot 3000 mm). 8 of 10 haken/kledinghangers per meter.

Van aluminium profiel, mat naturel geanodiseerd. Haken en/of kledinghangers en eindkappen kunststof: zwart.
Leverbaar in 5 verschillende accentkleuren.

GARDELUX ALLURE

Typ 9

einzelne Garderobestange mit Kleiderbügel und Hutablage. Länge bis 5000 mm (holz bis 3000 mm). 8 oder 10 Kleiderbügel pro Meter.

Typ 10

doppelte Garderobestange mit Haken, Kleiderbügel und Hutablage. Länge bis 5000 mm (holz bis 3000 mm). 8 oder 10 Haken/Kleiderbügel pro Meter.

Alu-profil, silber matt eloxiert. Haken und/oder kleiderbügel und Endkappen Kunststoff: schwarz.
In 5 verschiedenen Akzentfarben lieferbar.

GARDELUX ALLURE

type 9

single coat rack tube with coat hangers and shelf. Length till 5000 mm (wood till 3000 mm). 8 or 10 coat hangers per meter.

type 10

double coat rack tube with hooks, coat hangers and shelf. Length till 5000 mm (wood till 3000 mm). 8 or 10 hooks/coat hangers per meter.

Extruded aluminium, silver matt anodized. Hooks and/or coat hangers and endcaps plastic: black.
Can be supplied in 5 different accent colours.

GARDELUX ALLURE

modèle 9

tube de vestiaire simple avec cintres et planche pour chapeaux. Longueur à 5000 mm (bois à 3000 mm). 8 ou 10 cintres par mètre.

modèle 10

tube de vestiaire double avec crochets, cintres et planche pour chapeaux, longueur à 5000 mm (bois à 3000 mm). 8 ou 10 crochets/cintres par mètre.

En aluminium profilé, anodisé mat argent. Crochets et/ou cintres et embouts en matière plastique: noir.
Sont disponibles en 5 couleurs de complémentaires.

type 9

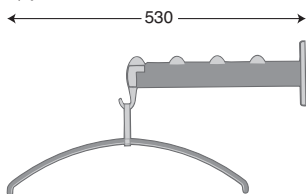

type 10

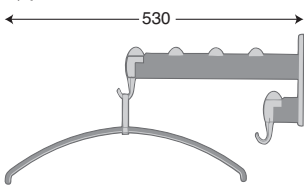

GARDEROBES | GARDELUX ALLURE

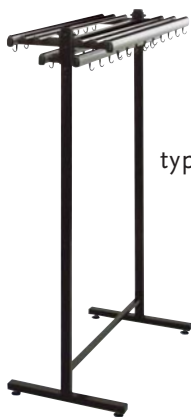

type 6



type 10



2265
(zie pag. 224)

GARDELUX ALLURE

op frame, enkelzijdig of dubbelzijdig. De frames worden standaard van stelvoeten voorzien. Andere mogelijkheden zijn zwenkwielen of stelplaten voor montage op de vloer (pagina 216).

GARDELUX ALLURE

auf einem Rahmen, einseitig oder doppelseitig. Die Rahmen sind in der Standardausführung mit Stellfüße versehen. Andere möglichkeiten sind Lenkrollen oder Feststellplatten (Seite 216).

GARDELUX ALLURE

on a frame, single sided or double sided. The frames are equipped as standard with adjustable feet. Other possibilities are castors or levelling plates (page 216).

GARDELUX ALLURE

avec un cadre, d'un seul côté ou des deux côtés. Les cadres disposent de façon standard des pieds réglables. Il existe d'autres possibilité's, comme des roulettes pivotantes ou des plaques réglables (page 216).



RAL 9011

RAL 5002

aluminium

beuken kersen

Buche Kirschbaum

Beech Cherry Tree

Hêtre Bois de Cerise

GARDELUX DOCK

GARDELUX DOCK Transparantie, vloeiende vormen en een minimale materiaaldikte. Aluminium vormt de basis van de revolutionaire Dock designgarderobe van Gardelux. Een uniek object, ontworpen om vrijwel naadloos en zonder zichtbare verbindingen iedere ruimte én iedere gebruiker de tand des tijds te laten doorstaan.

De kleuren Door de transparante inlay komen de lijnen van de garderobe extra goed tot hun recht. Door de verende bespanning van het doek vindt de garderobe na ieder "bezoek" zijn oorspronkelijke balans weer terug. Het doek is in zwart en wit verkrijgbaar. Materiaal: Netweave (100% met kunststof ommanteld polyesteraren).

De modellen De vrijwel naadloze aluminium garderobe in combinatie met de transparante inlay maken de Gardelux Dock tot de perfecte vervolmaking van uw woon- of kantoorinrichting. De Gardelux Dock is voorzien van 15 jashaken; 8 haken voor en 7 achter. De standaardlengte is 1036 mm. Kledinghangers zijn optioneel verkrijgbaar.

GARDELUX DOCK Transparenz, flüssige Formen und eine minimale Materialdicke. Aluminium ist das Grundmaterial der revolutionären Stilgarderobe Dock von Gardelux. Ein einmaliges Objekt dessen Entwurf dafür sorgt, dass jeder Raum und jeder Benutzer dem Zahn der Zeit widersteht.

Die Farben Die transparente Einlage lässt die Linien der Garderobe sehr gut zur Geltung kommen. Die elastische Bespannung des Stoffes sorgt dafür dass die Garderobe nach jedem "Besuch" ihr originales Gleichgewicht wiedereinnimmt. Der Stoff ist schwarz und weiß lieferbar. Material: Netweave (100% Polyesterfaden, mit Kunststoff bekleidet).

Die Modelle Dank der Kombination von Aluminium, praktisch ohne Nähte, mit einer transparenten Einlage, ist die Garderobe Dock von Gardelux die perfekte Perfektionierung des Interieurs Ihrer Wohnung oder Ihres Büros. Die Dock von Gardelux ist mit 15 Kleiderhaken ausgestattet: 8 vorne und 7 hinten. Die Standardlänge ist 1036 mm. Es gibt optionale Aufhänger.

GARDELUX DOCK Transparency, flowing lines and minimal thickness. Aluminium forms the basis of this revolutionary Dock coat rack design from Gardelux. A unique object, designed to make every space and every user withstand the test of time.

The colours The transparent inlay emphasizes the streamlining effect. The elasticity of the material ensures that the coat rack reverts to its original shape after use. The material is available in black and white, Material: Netweave (100% polyester thread enclosed by synthetic fibers).

The models The virtually seamless aluminium coat rack, combined with the transparent inlay, gives the Gardelux Dock the perfect finish to your home or office furnishing. The Gardelux Dock is provided with 15 coat hooks: 8 hooks in the front and 7 hooks at the back. The standard length is 1036 mm. Clothes hangers are optionally.

GARDELUX DOCK Transparence, formes coulantes en une épaisseur minimale du matériel. L'aluminium est le matériel de base de la vestiaires de style révolutionnaire Dock de Gardelux. Un objet unique dont la conception pratiquement sans soudures et sans raccordements visibles fait résister chaque espace et chaque utilisateur à l'injure du temps.

Les couleurs L'intercalaire transparent met très bien en valeur les lignes de la vestiaires reprend son équilibre original. L'étoffe est disponible en noir et en blanc. Matériel: Netweave (100% fil polyester revêtu de plastique).

Les modèles La combinaison de l'aluminium pratiquement sans soudures avec l'intercalaire transparent de la vestiaires Dock de Gardelux font qu'elle est le perfectionnement parfait de l'intérieur de votre maison ou bureau. La Dock de Gardelux est équipée de 15 patères: 8 en avant et 7 en arrière. La longueur standard est de 1036 mm. Il y a des portemanteaux en option.



GARDEROBES | GARDELUX DOCK

2440 type 4



GARDELUX DOCK
Aluminium garderobe in combinatie met transparante inlay. Kledinghangers zijn van aluminium met zwart kunststof. Lengte 1036 mm.

Aluminium in naturel mat geanodiseerd

2440 type 4

kleur
- 80 zwart
- 89 wit

GARDELUX DOCK
Aluminium Garderobe kombiniert mit einer transparenten Ablage. Kleiderbügel aus Aluminium mit schwarzem Kunststoff Haken. Länge 1036 mm.

Aluminium matt silber eloxiert

2440 type 4

Farbe
- 80 schwarz
- 89 weiss

GARDELUX DOCK
Aluminium coat rack combined with a transparent inlay. Aluminium coat hanger with black synthetic hook. Length 1036 mm.

Aluminium matt silver anodized

2440 type 4

colour
- 80 black
- 89 white

GARDELUX DOCK
Aluminium vestiaire en combinaison avec une planchet transparent. Les cintres sont faits de aluminium avec crochets plastiques noir. Longuer 1036 mm.

Aluminium anodisé argent mat

2440 type 4

couleur
- 80 noir
- 89 blanc

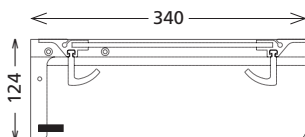

GARDEROBES | GARDELUX DOCK

2450 type 5

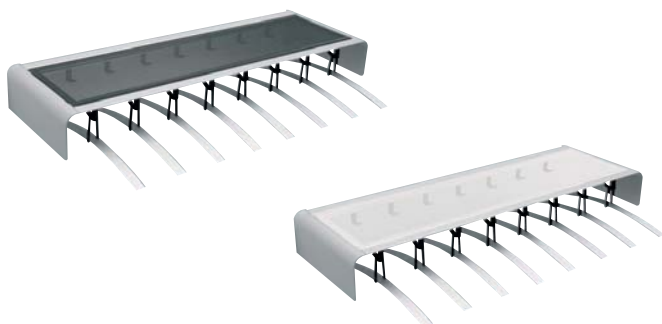

<p>GARDELUX DOCK Aluminium garderobe in combinatie met transparante inlay. Kledinghangers zijn van aluminium met zwart kunststof. Lengte 1036 mm.</p> <p>Aluminium in naturel mat geanodiseerd</p> <p>2450 type 5</p> <p>kleur - 80 zwart - 89 wit</p>	<p>GARDELUX DOCK Aluminium Garderobe kombiniert mit einer transparenten Ablage. Kleiderbügel aus Aluminium mit schwarzem Kunststoff Haken. Länge 1036 mm.</p> <p>Aluminium matt silber eloxiert</p> <p>2450 type 5</p> <p>Farbe - 80 schwarz - 89 weiss</p>	<p>GARDELUX DOCK Aluminium coatrack combined with a transparent inlay. Aluminium coat hanger with black synthetic hook. Length 1036 mm.</p> <p>Aluminium matt silver anodized</p> <p>2450 type 5</p> <p>colour - 80 black - 89 white</p>	<p>GARDELUX DOCK Aluminium vestiaire en combinaison avec une planchet transparent. Les cintres sont faits de aluminium avec crochets plastiques noir. Longueur 1036 mm.</p> <p>Aluminium anodisé argent mat</p> <p>2450 type 5</p> <p>couleur - 80 noir - 89 blanc</p>
--	---	--	--

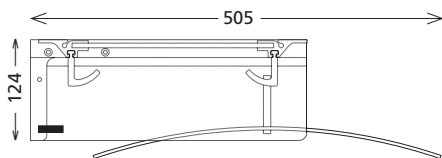



204



205



206



207



208

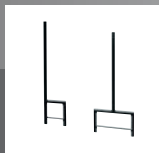

209



210



211



ZITBANKEN

SITZBÄNKE

BENCHES

BANCS

ZITBANKEN

type 1



ZITBANKEN	SITZBÄNKE	BENCHES	BANCS
Type 1 is te leveren met hardhouten, aluminium of kunststof zitting.	Typ 1 ist mit einer Sitzfläche aus Hartholz, Aluminium oder Kunststoff lieferbar.	Type 1 is available with a hardwooden, aluminium or plastic seat.	Modèle 1 est livrable avec des sièges en bois tropical, en aluminium ou en plastique.
Standaard lengtematen: 1150 en 2150 mm.	Standardlängen: 1150 und 2150 mm.	Standard lengths: 1150 and 2150 mm.	Les longueurs standard sont de 1150 et 2150 mm.
Ook leverbaar in elke gewenste lengte tot 4800 mm. (met uitzondering van kunststof zitting).	Darüber hinaus in jeder gewünschten Länge bis 4800 mm lieferbar. (mit Ausnahme von Kunststoff Sitzelemente).	Also available in any chosen length to a maximum of 4800 mm. (with the exception of plastic seat elements).	Il est aussi possible d'obtenir des bancs de toutes les longueurs désirées jusqu' à un maximum de 4800 mm. (à l'exception des éléments de siège en matière plastique).
-70 zwart RAL 9011	-70 schwarz RAL 9011	-70 black RAL 9011	-70 noir RAL 9011

ZITBANKEN

type 3



ZITBANKEN	SITZBÄNKE	BENCHES	BANCS
Type 3 is te leveren met hardhouten, aluminium of kunststof zitting.	Typ 3 ist mit einer Sitzfläche aus Hartholz, Aluminium oder Kunststoff lieferbar.	Type 3 is available with a hardwooden, aluminium or plastic seat.	Modèle 3 est livrable avec des sièges en bois tropical, en aluminium ou en plastique.
Standaard lengtematen: 1150 en 2150 mm, met of zonder schoenenrek.	Standardlängen: 1150 und 2150 mm, mit oder ohne Schuhe Rack.	Standard lengths: 1150 and 2150 mm, with or without shoes rack.	Les longueurs standard sont de 1150 et 2150 mm, avec ou sans bac à chaussures.
Ook leverbaar in elke gewenste lengte tot 4800 mm. (met uitzondering van kunststof zitting).	Darüber hinaus in jeder gewünschten Länge bis 4800 mm lieferbar. (mit Ausnahme von Kunststoff Sitzelemente).	Also available in any chosen length to a maximum of 4800 mm. (with the exception of plastic seat elements).	Il est aussi possible d'obtenir des bancs de toutes les longueurs désirées jusqu' à un maximum de 4800 mm. (à l'exception des éléments de siège en matière plastique).
-70 zwart RAL 9011	-70 schwarz RAL 9011	-70 black RAL 9011	-70 noir RAL 9011

ZITBANKEN MET GARDEROBE

type 5



ZITBANKEN MET GARDEROBE	SITZBÄNKE MIT GARDEROBE	BENCHES WITH COAT RACK	BANCS AVEC VESTIAIRE
Type 5 is te leveren met hardhouten, aluminium of kunststof zitting.	Typ 5 ist mit einer Sitzfläche aus Hartholz, Aluminium oder Kunststoff lieferbar.	Type 5 is available with a hardwooden, aluminium or plastic seat.	Modèle 5 est livrable avec des sièges en bois tropical, en aluminium ou en plastique.
Standaard lengtematen: 1150 en 2150 mm, met of zonder schoenenrek.	Standardlängen: 1150 und 2150 mm, mit oder ohne Schuhe Rack.	Standard lengths: 1150 and 2150 mm, with or without shoes rack.	Les longueurs standard sont de 1150 et 2150 mm, avec ou sans bac à chaussures.
Ook leverbaar in elke gewenste lengte tot 4800 mm. (met uitzondering van kunststof zitting).	Darüber hinaus in jeder gewünschten Länge bis 4800 mm lieferbar. (mit Ausnahme von Kunststoff Sitzelemente).	Also available in any chosen length to a maximum of 4800 mm. (with the exception of plastic seat elements).	Il est aussi possible d'obtenir des bancs avec vestiaire de toutes les longueurs désirées jusqu'à un maximum de 4800 mm. (à l'exception des éléments de siège en matière plastique).
-70 zwart RAL 9011	-70 schwarz RAL 9011	-70 black RAL 9011	-70 noir RAL 9011

ZITBANKEN MET GARDEROBE

type 6



ZITBANKEN MET GARDEROBE	SITZBÄNKE MIT GARDEROBE	BENCHES WITH COAT RACK	BANCS AVEC VESTIAIRE
Type 6 is te leveren met hardhouten, aluminium of kunststof zitting.	Typ 6 ist mit einer Sitzfläche aus Hartholz, Aluminium oder Kunststoff lieferbar.	Type 6 is available with a hardwooden, aluminium or plastic seat.	Modèle 6 est livrable avec des sièges en bois tropical, en aluminium ou en plastique.
Standaard lengtematen: 1150 en 2150 mm, met of zonder schoenenrek.	Standardlängen: 1150 und 2150 mm, mit oder ohne Schuhe Rack.	Standard lengths: 1150 and 2150 mm, with or without shoes rack.	Les longueurs standard sont de 1150 et 2150 mm, avec ou sans bac à chaussures.
Ook leverbaar in elke gewenste lengte tot 4800 mm. (met uitzondering van kunststof zitting).	Darüber hinaus in jeder gewünschten Länge bis 4800 mm lieferbar. (mit Ausnahme von Kunststoff Sitzelemente).	Also available in any chosen length to a maximum of 4800 mm. (with the exception of plastic seat elements).	Il est aussi possible d'obtenir des bancs avec vestiaire de toutes les longueurs désirées jusqu'à un maximum de 4800 mm. (à l'exception des éléments de siège en matière plastique).
-70 zwart RAL 9011	-70 schwarz RAL 9011	-70 black RAL 9011	-70 noir RAL 9011

STEUNEN VOOR ZITBANKEN



3061

3063

STEUNEN EN VERBINDINGSREGELS VOOR ZITBANKEN	TRÄGER UND VERBINDUNGSSATZ FÜR SITZBÄNKE	SUPPORTS AND CONNECTING TUBES FOR BENCHES	SUPPORTS ET BARRES DE RACCORDEMENT LATÉRALES POUR BANCS
3061 voor bank type 1 3063 voor bank type 3	3061 für Bänke Typ 1 3063 für Bänke Typ 3	3061 for bench type 1 3063 for bench type 3	3061 pour banc modèle 1 3063 pour banc modèle 3
verbindingsregels voor 3063: 1338 L=700mm 1339 L=970mm	verbindingssatz für 3063: 1338 L=700mm 1339 L=970mm	connecting tubes for 3063: 1338 L=700mm 1339 L=970mm	barres pour 3063: 1338 L=700mm 1339 L=970mm
staal geëpoxeerd -70 zwart RAL 9011	Stahl kunststoff- beschichtet -70 schwarz RAL 9011	steel epoxy plastic coated -70 black RAL 9011	en acier rilsané -70 noir RAL 9011

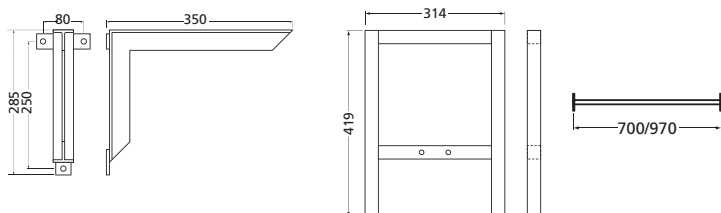

STANDAARDS VOOR ZITBANKEN MET GARDEROBE

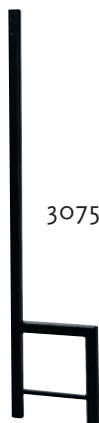

3075



3076

STANDAARDS EN VERBINDINGSREGELS VOOR ZITBANKEN MET GARDEROBE	RAHMEN UND VERBINDUNGSSATZ FÜR SITZBÄNKE MIT GARDEROBE	FRAMES AND CONNECTING TUBES FOR BENCHES WITH COAT RACK	PILIERS ET BARRES DE RACCORDEMENT LATERALES POUR BANCOS AVEC VESTIAIRE
3075 voor bank type 5 3076 voor bank type 6	3075 für Bänke Typ 5 3076 für Bänke Typ 6	3075 for bench type 5 3076 for bench type 6	3075 pour banc modèle 5 3076 pour banc modèle 6
verbindingsregels 1338 L=700mm 1339 L=970mm	verbindungssatz 1338 L=700mm 1339 L=970mm	connecting tubes 1338 L=700mm 1339 L=970mm	barres 1338 L=700mm 1339 L=970mm
staal geëpoxeerd -70 zwart RAL 9011	stahl kunststoff- beschichtet -70 schwarz RAL 9011	steel epoxy plastic coated -70 black RAL 9011	en acier rilsanisé -70 noir RAL 9011

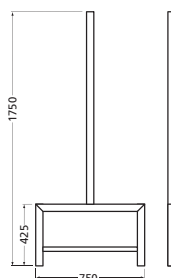
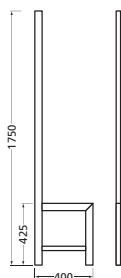

BANKPROFIELEN EN ZITDELEN



ZITDEEL	SITZLEISTE	RAIL FOR BENCHES	LATTE POUR BANCS
van hardhout 3007 90 mm breed, 25 mm dik	aus hartholz 3007 90 mm Breite, 25 mm Stärke.	hardwood 3007 90 mm wide, 25 mm thick.	en bois tropical 3007 90 mm largeur, 25 mm épaisseur.
Standaard lengtematen 1150 en 2150 mm. Ook leverbaar in elke gewenste lengte tot 4800 mm	Standardlängen 1150 und 2150 mm. Darüber hinaus in jeder gewünschten Länge bis 4800 mm lieferbar	Standard lengths 1150 and 2150 mm. Also available in any chosen length to a maximum of 4800 mm	Les longueurs standard sont de 1150 et 2150 mm. Aussi de toutes les longueurs désirées jusqu'à un maximum de 4800 mm
van kunststof 105 mm breed, 35 mm dik 3008 - L = 1150 mm 3009 - L = 2150 mm	von Kunststoff 105 mm Breite, 35 mm Stärke. 3008 - L = 1150 mm 3009 - L = 2150 mm	plastic 105 mm wide, 35 mm thick. 3008 - L = 1150 mm 3009 - L = 2150 mm	en plastique 105 mm largeur, 35 mm épaisseur. 3008 - L = 1150 mm 3009 - L = 2150 mm
BANKPROFIEL 3000	SITZLEISTE 3000	RAIL FOR BENCHES 3000	LATTE POUR BANCS 3000
aluminium profiel 25 x 30 mm leverlengte 5000 mm	Leichtmetall Profil 25 x 30 mm Lieferlänge 5000 mm	aluminium profile 25 x 30 mm standard length 5000 mm	en aluminium profilé 25 x 30 mm longueur standard 5000 mm
geanodiseerd, -11 mat naturel	eloxiert -11 matt silber	anodized -11 matt silver	anodisé -11 argent mat
EINDSTOP 3005	ENDKAPPE 3005	END CAP 3005	EMBOUT 3005
(voor profiel 3000) kunststof -80 zwart	(für profil 3000) kunststoff -80 schwarz	(for rail 3000) plastic -80 black	(pour profil 3000) plastique -80 noir

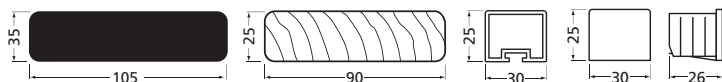

SCHOENENREK

3010



SCHOENENREK 97 cm	SCHUHE RACK 97 cm	SHOE RACK 97 cm	BAC À CHAUSSURES 97 cm
t.b.v. zitbank type 3, 5, 6	für Banke Typ 3, 5, 6	for bench type 3, 5, 6	pour banc modèle 3, 5, 6
staal geëpoxeerd	Stahl kunststoff- beschichtet	steel epoxy plastic coated	en acier rilsanisé
-70 zwart RAL 9011	-70 schwarz RAL 9011	-70 black RAL 9011	-70 noir RAL 9011

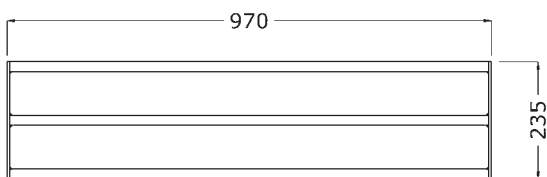



214



215



216



217



218



219



220



221



222



223



224

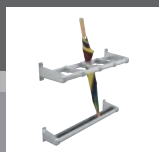

225



226

GARDEROBEFRAMES, KAPSTOKKEN,
JASSENREK, PARAPLUSTANDAARDS
EN URINOIRSCHOT

RAHMEN FÜR GARDEROBEN,
GARDEROBENSTÄNDER,
KLEIDERSTÄNDER, SCHIRMSTÄNDER
UND URINALTRENNWAND

FRAMES, COAT STANDS, COAT RACKS,
UMBRELLA STANDS
AND URINAL PARTITION

CADRES DE VESTIAIRE,
PORTE-MANTEAUX À PIED,
PORTE-MANTEAUX, PORTE-PARAPLUIES
ET PARTITION URINOIR

GARDEROBEFRAMES



FRAMES ENKELZIJDIG standaards en verbindingsregels van stalen kokerprofiel	RAHMEN EINSEITIG Ständer und Verbindungssatz aus Stahlrohr	FRAMES SINGLE SIDED steel uprights and connecting tubes	CADRES D'UN SEUL CÔTÉ piliers et barres de raccordement laterales, en acier
geëpoxeerd -70 zwart RAL 9011	kunststoffbeschichtet -70 schwarz RAL 9011	epoxy plastic coated -70 black RAL 9011	rilsanisé -70 noir RAL 9011
verbindingsregels 1338 L= 700mm 1339 L= 970 mm	verbindingssatz 1338 L= 700mm 1339 L= 970 mm	connecting tubes 1338 L= 700mm 1339 L= 970 mm	barres 1338 L= 700mm 1339 L= 970 mm
N.B. Stelvoeten, stelplaten of zwenkwielen apart bestellen. (pag. 216)	Achtung: Stellfüsse, Feststellplatten oder Lenkrollen müssen zusätzlich bestellt werden. (Seite 216)	Note: Adjustable feet, levelling plates or castors to be ordered separately. (page 216)	Attention: des pieds, des plaques de base et des roulettes pivotantes sont à commander selon votre besoin. (page 216)

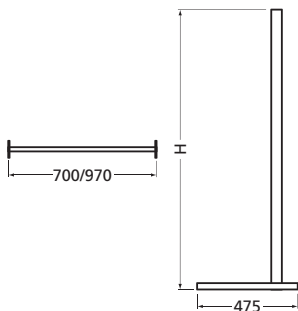

	H
1331	1300
1332	1600
1333	1750

GARDEROBEFRAMES



FRAMES DUBBEL-ZIJDIG	RAHMEN DOPPEL-SEITIG	FRAMES DOUBLE SIDED	CADRES DES DEUX CÔTÉS
standaards en verbindingregels van stalen kokerprofiel	Ständer und Verbindungssatz aus Stahlrohr	steel uprights and connecting tubes	piliers et barres de raccordement laterales, en acier
geëpoxeerd -70 zwart RAL 9011	kunststoffbeschichtet -70 schwarz RAL 9011	epoxy plastic coated -70 black RAL 9011	rilsanisé -70 noir RAL 9011
verbindingregels 1338 L= 700mm 1339 L= 970 mm	verbindingssatz 1338 L= 700mm 1339 L= 970 mm	connecting tubes 1338 L= 700mm 1339 L= 970 mm	barres 1338 L= 700mm 1339 L= 970 mm
N.B. Stelvoeten, stelplaten of zwenkwielen apart bestellen. (pag. 216)	Achtung: Stellfüsse, Feststellplatten oder Lenkrollen müssen zusätzlich bestellt werden. (Seite 216)	Note: Adjustable feet, levelling plates or castors to be ordered separately. (page 216)	Attention: des pieds, des plaques de base et des roulettes pivotantes sont à commander selon votre besoin. (page 216)

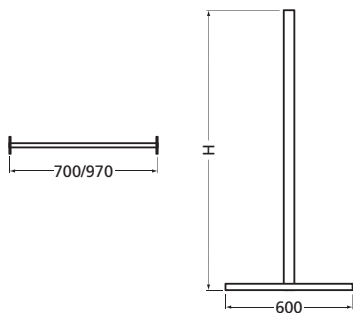

H	
1335	1300
1336	1600
1337	1750

STELVOETEN EN ZWENKWIELEN



1355



1356



1366

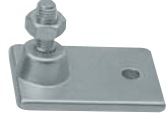

1365

STELVOET	STELLFUSS	ADJUSTABLE FOOT	PIED REGLABLE
1366-80 met M10 draadeind, zwarte kunststof schotel	1366-80 mit M10 Gewinde, Stellfuss Kunststoff schwarz	1366-80 with M10 threaded rod, black plastic foot	1366-80 avec tige fileté M10, pied en plastique noir
STELPLAAT	FESTSTELLPLATTE	LEVELLING PLATE	PLAQUE REGLABE
1365-01 met M10 draadeind, aluminium naturel geanodiseerd	1365-01 mit M10 Gewinde, Leichtmetall silber eloxiert	1365-01 with M10 threaded rod, silver anodized	1365-01 avec tige fileté M10, aluminium anodisé argent
ZWENKWIEL	LENKROLLE	CASTOR	ROULETTE PIVOTANTE
gegalvaniseerd staal met M10 draadeind	verzinkt Stahleblech mit Gewinde M10	galvanized steel with M10 threaded rod	en acier galvanisé avec tige fileté M10
1355-99 zonder rem 1356-99 met rem	1355-99 ohne Bremse 1356-99 mit Bremse	1355-99 without brake 1356-99 with brake	1355-99 sans frein 1356-99 avec frein

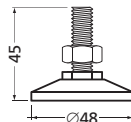
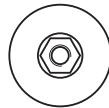
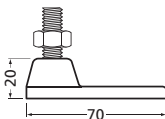
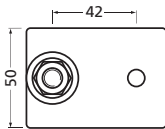

STAANDE KAPSTOK

2250 original



Staande kapstok met 8 dubbele jas-/hoed haken, ronde kroon van gegoten aluminium, staander en haken naturel geanodiseerd, hoog 1800 mm

Freistehender Garderobenständer mit 8 doppel Mantel- und Huthaken, runde Krone aus gegossenem Aluminium, Ständer und Haken naturel eloxiert, Höhe 1800 mm

Coat stand with 8 double coat and hat hooks, round crown of cast aluminium, stands and hooks silver anodized, height 1800 mm

Porte-manteau à pied avec 8 double crochets porte manteau et porte chapeau, couronne circulaire d'aluminium coule, support et crochets anodisé de façon naturelle, hauteur 1800 mm

2250-74 kroon en voet graphite grey
2250-754 kroon en voet blue haze
2250-79 kroon en voet pure white

2250-74 Krone und Fuss graphite grey
2250-754 Krone und Fuss blue haze
2250-79 Krone und Fuss pure white

2250-74 crown and base graphite grey
2250-754 crown and base blue haze
2250-79 crown and base pure white

2250-40 couronne et pied graphite grey
2250-754 couronne et pied blue haze
2250-79 couronne et pied pure white

STAANDE KAPSTOK GARDELUX GEAR



2258



GARDELUX GEAR Aluminium staande kapstok met 16 haken, ronde kroon en ronde voet.	GARDELUX GEAR Leichtmetall freistehender Garderobenständer mit 16 haken, runde Krone und Füße.	GARDELUX GEAR Aluminium coat stand with 16 hooks, round crown and round base.	GARDELUX GEAR Aluminium porte-manteau à pied avec 16 crochets, couronne circulaire et pied circulaire.
Kroon, voet en staander geanodiseerd. Hoog 1750 mm	Krone, Fuss und Ständer eloxiert. Höhe 1750 mm	Crown, base and stands anodized. Height 1750 mm	Couronne, pied et support anodisé. Hauteur 1750 mm
2258-11 mat naturel	2258-11 matt silber	2258-11 matt silver	2258-11 argent mat

STAANDE KAPSTOK GARDELUX OAK



2259

<p>GARDELUX OAK Staande kapstok met 5 jas-/hoedhaken van aluminium, geanodiseerd.</p>	<p>GARDELUX OAK Freistehender Garderobenständer mit 5 Mantel- und Huthaken von Aluminium, silber eloxiert.</p>	<p>GARDELUX OAK Coat stand with 5 coat and hat hooks of aluminium, silver anodized.</p>	<p>GARDELUX OAK Porte-manteau à pied avec 5 crockets porte manteau et porte chapeau d'aluminium, anodisé argent.</p>
<p>Staander en voet van eikenhout. Hoogte 1850 mm</p>	<p>Ständer und Fuss aus Eichenholz. Höhe 1850 mm</p>	<p>Stand and base of oak wood. Height 1850 mm</p>	<p>Support et pied chêne. Hauteur 1850 mm</p>
<p>2259-36 eikenhout, geborsteld</p>	<p>2259-36 Eichenholz, gebürstet</p>	<p>2259-36 oak wood, brushed</p>	<p>2259-36 chêne, brossé</p>

JASSENREK



JASSENREK	GARDEROBENSTÄNDER	COAT RACK	PORTE-MANTEAUX
Jassenrek van staal met houten kledinghangers.	Garderobenständer aus Stahl mit Holz Kleiderbügel.	Coat rack made of steel with wooden hangers.	Porte-manteaux en acier avec bois cintres.
Rekken zijn te koppelen en aantal kledinghangers is variabel.	Regale können miteinander verbunden werden und die Anzahl Kleiderbügel ist variabel.	Shelves can be linked and the number of hangers is variable.	Les étagères peuvent être liés et le nombre de cintres est variable.
Keuze uit stelvoeten of zwenkwielen	Wahlweise verstellbaren Füßen oder Rollen	Choice between adjustable feet or castors	Choix de pieds réglables ou roulettes
Hoogte 2010 mm	Höhe 2010 mm	Height 2010 mm	Hauteur 2010 mm
Lengte in secties van 1 meter of op aanvraag	Länge in Abschnitte 1 m oder auf Anfrage	Length in sections 1 meter or on request	Longueur en sections 1 mètre ou à la demande
1345 jassenrek 1 meter (exclusief hangers) 1346 jassenrek aanbouw 1 meter (exclusief hangers) 1269-99 kledinghanger	1345 Garderobenständer 1 Meter (ohne Kleiderbügel) 1346 Garderobenständer Erweiterung 1 Meter (ohne Kleiderbügel) 1269-99 Kleiderbügel	1345 coat rack 1 meter (excluding hangers) 1346 coat rack expansion 1 meter (excluding hangers) 1269-99 hangers	1345 porte-manteaux 1 mètre (sans cintres) 1346 expansion porte-manteaux 1m (sans cintres) 1269-99 cintres
geëpoxeerd -70 zwart RAL 9011	kunststoffbeschichtet -70 schwarz RAL 9011	epoxy plastic coated -70 black RAL 9011	rilsanisé -70 noir RAL 9011
Andere kleuren op aanvraag.	Andere Farben auf Anfrage.	Other colours on demand.	Autres couleurs sur demande.

PARAPLUSTANDAARDS

2270 | 2271



PARAPLUSTANDAARD vrijstaand	SCHIRMSTÄNDER freistehend	UMBRELLA STAND freestanding	PORTE-PARAPLUIES indépendant
aluminium profiel, naturel geanodiseerd, staanders van HPL plaatmateriaal: grijs	Alu-Profil, naturell eloxiert, Ständer aus HPL platte: grau	aluminium profile, na- tural anodized, stands of solid grade, grey	en aluminium profilé, anodisé mat argent, cadres stratifié masif, gris
standaard lengtematen: 550 en 1050 mm	Standardlängen: 550 und 1050 mm	standard lengths: 550 and 1050 mm	longueurs standard: 550 et 1050 mm
2270-11 met 5 vakken, lengte 550 mm 2271-11 met 10 vakken, lengte 1050 mm	2270-11 mit 5 Plätze, Länge 550 mm 2271-11 mit 10 Plätze, Länge 1050 mm	2270-11 with 5 compart- ments, length 550 mm 2271-11 with 10 compartments, length 1050 mm	2270-11 avec 5 places, longueur 550 mm 2271-11 avec 10 places, longueur 1050 mm

PARAPLUSTANDAARDS



2260 | 2261



2262 | 2263

PARAPLUSTANDAARD	SCHIRMSTÄNDER	UMBRELLA STAND	PORTE-PARAPLUIES
aluminium profiel, naturel geanodiseerd, steunen resp. frame staal geëpoxeerd	Alu-Profil, naturell eloxiert, Träger bzw. Rahmen aus Stahl, kunststoffbeschichtet	aluminium profile, natural anodized, wall supports or frames made of steel, epoxy plastic coated	en aluminium profilé, anodisé mat argent, supports ou cadres en acier, rilsanisé
standaard lengtematen 550 en 1050 mm	Standardlängen 550 und 1050 mm	Standard lengths: 550 and 1050 mm	Les longueurs standard sont 550 et 1050 mm
2260 - wandmontage, lengte 550 mm 2261 - wandmontage, lengte 1050 mm 2262 - vrijstaand, lengte 550 mm 2263 - vrijstaand, lengte 1050 mm	2260 - Wandbefestigung, Länge 550 mm 2261 - Wandbefestigung, Länge 1050 mm 2262 - Freistehend, Länge 550 mm 2263 - Freistehend, Länge 1050 mm	2260 - wall mounting, length 550 mm 2261 - wall mounting, length 1050 mm 2262 - freestanding, length 550 mm 2263 freestanding, length 1050 mm	2260 - installation murale, longueur 550 mm 2261 - installation murale, longueur 1050 mm 2262 - indépendant, longueur 550 mm 2263 - indépendant, longueur 1050 mm
-70 zwart RAL 9011	-70 schwarz RAL 9011	-70 black RAL 9011	-70 noir RAL 9011

PARAPLUHOUDER

2268 | 2269



PARAPLUHOUDER	SCHIRMSTÄNDER	UMBRELLA STAND	PORTE-PARAPLUIES
te plaatsen tussen garderobe frames	für die Befestigung zwischen Garderoben raumen	for mounting between coat frames	pour la fixation entre les cadres
aluminium profiel, geanodiseerd	Leichtmetall, eloxiert	extruded aluminum, anodized	en profilé d'aluminium, anodisé
2268 L= 700mm 2269 L= 970mm	2268 L= 700mm 2269 L= 970mm	2268 L= 700mm 2269 L= 970mm	2268 L= 700mm 2269 L= 970mm
-11 mat naturel	-11 matt silber	-11 matt silver	-11 argent mat

PARAPLUHOUDER

2265



PARAPLUHOUDER	SCHIRMSTÄNDER	UMBRELLA STAND	PORTE-PARAPLUIES
voor garderobe frame	für die Befestigung gegen garderoben raumen	for mounting on coat frames	montage cadres de porte maners
staal geëpoxeerd	Stahl kunststof beschichtet	steel, epoxy plastic coated	acier, rilsanisé
-70 zwart RAL 9011	-70 schwarz RAL 9011	-70 black RAL 9011	-70 noir RAL 9011

PARAPLUHOUDERS | GARDELUX 1

2280



PARAPLUHOUDER	SCHIRMSTÄNDER	UMBRELLA STAND	PORTE-PARAPLUIES
<p>Aluminium. Wandmontage, lengte 605 mm, 4-vaks</p> <p>geanodiseerd -01 naturel -02 nieuw zilver</p>	<p>Aluminium. Wandbefestigung, Länge 605 mm, mit 4 Plätze</p> <p>eloxiert -01 silber -02 neusilber</p>	<p>Aluminium. Wall mounting, length 605 mm, 4 compartments</p> <p>anodized -01 silver -02 continental</p>	<p>Aluminium. Installation murale, longuer 605 mm, avec 4 places</p> <p>anodisé -01 argent -02 champagne</p>

URINOIRSCHOT

5510



URINOIRSCHOT	URINALTRENNWAND	URINAL PARTITION	PARTITION URINOIR
HPL plaatmateriaal, dikte 13 mm, met aluminium mat naturel geanodiseerde steunen incl. bevestigingsmateriaal voor aan de wand (steen)	HPL Material 13mm, mit matt Silber Leichtmetall Eloxierte Träger einschliesslich Verbindungssatz für die Wand (Stein)	HPL material 13mm, with matt natural aluminium anodized supports included connecting material for the wall (stone)	HPL matériel 13mm, avec agent mat d'aluminium anodisé supports et barres de raccordement pour le mur (pierre)
Afmeting urinoirschot h x b = 750 x 400 mm	Grösse Trennwand 750 x 400 mm	sizes partition 750 x 400 mm	Dimensions 750 x 400 mm
kleur -79 wit	Farbe -79 Weiss	colour -79 White	couleur -79 Blanc
Andere kleuren op aanvraag	Andere Farben auf Anfrage	Other colours on demand	Autres couleurs sur demande



Art.nr.	pag.	Art.nr.	pag.
0010.....	12	1030.....	160
0011.....	12	1032.....	160
0026.....	13	1040.....	160
0027.....	13	1042.....	160
0028.....	14	1050.....	163
0029.....	14	1052.....	163
0030.....	15	1070 t/m 1072.....	163
0031.....	15	1080 t/m 1082.....	163
0032.....	16	1090 t/m 1092.....	163
0033.....	16	1100 t/m 1102.....	165
0034.....	17	1110 t/m 1112.....	165
0035.....	17	1130 t/m 1132.....	165
0138.....	18	1140 t/m 1142.....	165
0139.....	18	1150 t/m 1152.....	166
0148.....	19	1160 t/m 1162.....	166
0149.....	19	1170.....	159
0200.....	20	1175.....	159
0201.....	20	1180.....	159
0202.....	21	1190.....	161
0551.....	26	1192.....	161
0553.....	26	1194.....	161
0555.....	27	1196.....	161
0557.....	27	1199.....	165
0559.....	27	1201.....	167
0560.....	28	1205.....	33
0591.....	33	1220.....	167
0652 t/m 0655.....	29	1221.....	167
0663.....	30	1230.....	167
0665.....	30	1231.....	167
0670.....	22	1260.....	168
0672 t/m 0675.....	34	1261.....	168
0683.....	31	1262.....	169/185
0685.....	31	1263.....	169/185
0690.....	22	1264.....	185
0692 t/m 0695.....	34	1265.....	169
0804.....	42	1266.....	169
0811.....	43	1269.....	220
0820.....	23	1270.....	170
0822 t/m 0825.....	35	1275.....	170
0830.....	23	1280.....	170
0832 t/m 0835.....	35	1285.....	170
0840.....	24	1290.....	170
0842 t/m 0845.....	36	1291.....	170
0860.....	24	1331 t/m 1333.....	214
0862 t/m 0865.....	36/37	1335 t/m 1337.....	215
0870.....	24	1338.....	208/209/214/215
0872 t/m 0875.....	36	1339.....	208/209/214/215
0880.....	25	1345.....	220
0882 t/m 0885.....	38	1346.....	220
0890.....	25	1355.....	216
0898.....	39	1356.....	216
0899.....	39	1365.....	216
1010.....	158	1366.....	140/216
1011.....	158	1900.....	32
1015 t/m 1019.....	158	1909.....	32

Art.nr.	pag.	Art.nr.	pag.
2000.....	181	3360.....	128
2001.....	181	3361.....	128
2005.....	181	3370.....	130
2015.....	183	3430.....	65
2070 t/m 2072.....	189	3435.....	65
2081 t/m 2083.....	184	3440.....	65
2085.....	184	3441.....	65
2091 t/m 2095.....	183	3445.....	65
2100.....	187	3446.....	65
2105.....	187	3500.....	46
2111.....	187	3501.....	46
2130.....	190	3502.....	47
2131.....	190	3503.....	47
2135.....	190	3505.....	48
2136.....	190	3506.....	48
2140.....	190	3507.....	49
2141.....	190	3508.....	49
2145.....	190	3510.....	56
2150.....	189	3511 t/m 3514.....	58
2151.....	189	3515.....	56
2155.....	189	3516.....	58
2156.....	189	3520.....	57
2160.....	186	3521.....	59
2161.....	186	3522.....	59
2165.....	120/186	3523.....	59
2250.....	217	3524.....	59
2258.....	218	3525.....	57
2259.....	219	3526.....	59
2260 t/m 2263.....	222	3527.....	59
2265.....	180/197/224	3530 t/m 3538.....	61
2268.....	223	3540.....	50
2269.....	223	3541.....	50
2270.....	221	3542.....	51
2271.....	221	3543.....	51
2280.....	225	3545.....	52
2350 t/m 2352.....	191	3546.....	52
2440.....	200	3547.....	53
2450.....	201	3548.....	53
2650.....	40	3562 t/m 3567.....	63
2655.....	40	3570.....	54
2660.....	40	3580.....	55
2670.....	40	3581.....	55
2671.....	40	3585.....	54
2680 t/m 2685.....	41	3600.....	160
3000.....	181/210	3650.....	135
3005.....	186/210	3670.....	135
3007 t/m 3009.....	210	3675.....	135
3010.....	211	3679.....	135
3061.....	208	3731.....	97
3063.....	208	3732.....	97
3075.....	209	3751 t/m 3753.....	96
3076.....	209	3755.....	95
3275.....	131	3850.....	135
3280.....	131	3870.....	135
3350.....	128	3875.....	135

Art.nr.	pag.	Art.nr.	pag.
3879.....	135	5620.....	140
4067.....	98	5621.....	140
4069.....	98	5740.....	142
4087.....	98	5742.....	142
4089.....	98	5745.....	142
4190 t/m 4193.....	99	5801.....	113
4200 t/m 4205.....	100	5855.....	141
4221 tm 4223.....	101	5865.....	141
4231 t/m 4233.....	102	5870.....	141
4250.....	103	5900.....	142
4251.....	103	5935.....	142
4255 t/m 4258.....	104	5940.....	142
4260.....	105	5945.....	142
4265.....	105	5950.....	142
4268.....	105	5965.....	142
4270.....	105	5990.....	59/142
4300 t/m 4302.....	110	F1101xxx.....	68
4310 t/m 4312.....	110	F1111xxx.....	69
4321 t/m 4325.....	111	F1161xxx.....	70
4330.....	112	F1201xxx.....	71
4335.....	112	F1211xxx.....	72
4346.....	113	F1221xxx.....	73
4350.....	114	F1233xxx.....	74
4550.....	106	F2103xxx.....	75
4552.....	106	F2134xxx.....	76
4554.....	107	F3121xxx.....	77/88
4555.....	107	F3131xxx.....	78
4556.....	108	F3141xxx.....	79
4558.....	108	F3411xxx.....	80
4560.....	109	F3511xxx.....	81
4562.....	109	F3521xxx.....	82
4565.....	106	F3531xxx.....	83
4566.....	106	F3541xxx.....	84/89
4700.....	115	F3670xxx.....	90
4702.....	115	F3671xxx.....	91
4704.....	115	F3731xxx.....	85
4709.....	115	F5101xxx.....	86/92
4730.....	116	F5701xxx.....	87/93
4735.....	116	F5901xxx.....	94
4750.....	115		
4760.....	117		
4765.....	117		
4770.....	117		
5110.....	138		
5111.....	138		
5113.....	138		
5200 t/m 5204.....	120		
5210 t/m 5240.....	121		
5500.....	124		
5504 t/m 5506.....	125		
5510.....	226		
5605.....	139		
5607.....	139		
5609.....	139		
5610.....	139		

Aantekeningen / Notizen / Notes / Notes:

Grid area for notes.

Aantekeningen / Notizen / Notes / Notes:

A large grid of small squares, intended for taking notes. The grid is composed of many small, light gray squares arranged in a regular pattern, covering most of the page area below the header and above the footer.

Aantekeningen / Notizen / Notes / Notes:

Grid area for notes.

Aantekeningen / Notizen / Notes / Notes:

Aantekeningen / Notizen / Notes / Notes:

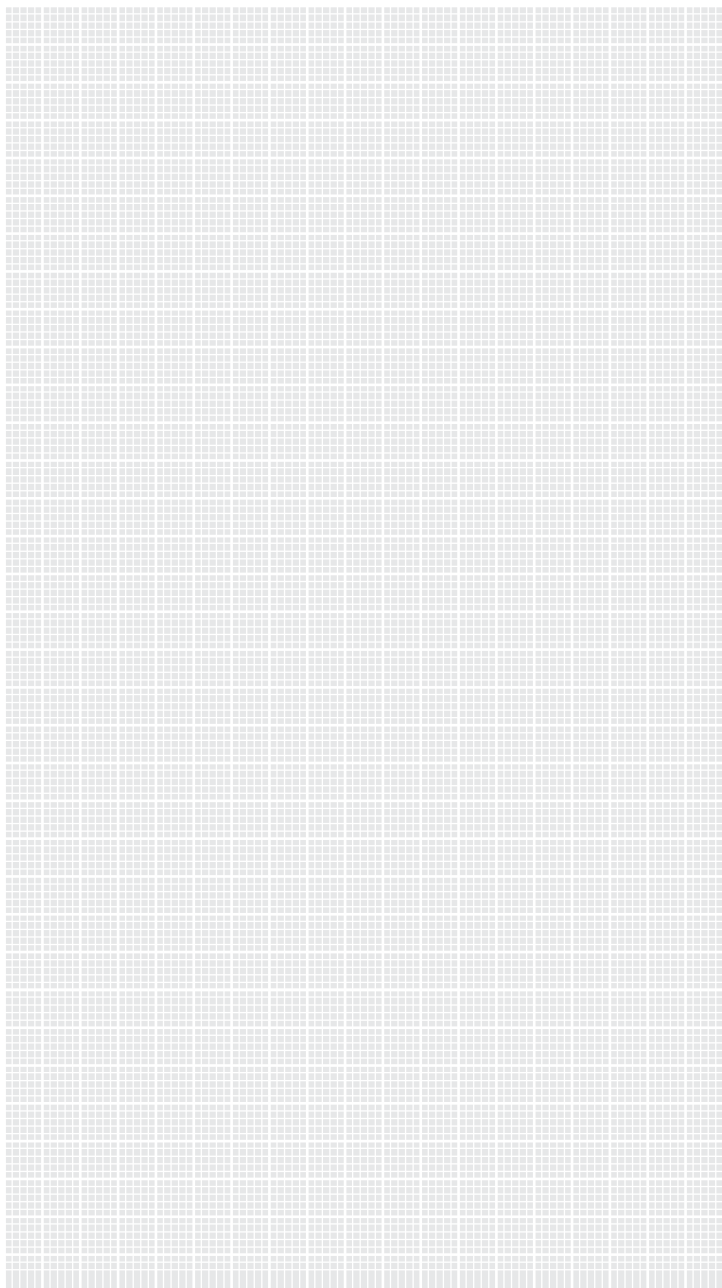



UITGAVE 2017 Hermeta bezit alle exclusieve rechten betreffende ontwerp, constructie en presentatie van de in deze catalogus afgebeelde artikelen. Gehele of gedeeltelijke overname is uitsluitend geoorloofd na verleende schriftelijke toestemming door Hermeta Metaalwaren bv te Asperen.

Afbeeldingen, afmetingen en uitvoering zoals in deze catalogus getoond, zijn niet bindend; publicatie vindt plaats onder voorbehoud.

Alle leveringen en transacties vinden plaats volgens de Algemene Leveringsvoorwaarden van de Vereniging Fabrieken van Hang- en Sluitwerk (VHS) en Algemene Leveringsvoorwaarden van de Vereniging Fabrikanten IJzerwaren en Gereedschappen (IJG).



AUSGABE 2017 Hermeta besitzt alle Rechte bezüglich Entwurf, Konstruktion und Präsentation aller in diesem Katalog abgebildeten Artikel. Ganze oder teilweise Übernahme ist ausschließlich erlaubt nach schriftlich erteilte Zustimmung von Hermeta Metaalwaren bv in Asperen, Niederlande.

Abbildungen, Abmessungen und Ausführung in diesem Katalog sind unverbindlich. Veröffentlichung geschieht unter Vorbehalt.

Alle Lieferungen und Geschäfte geschehen gemäß den Allgemeinen Lieferbedingungen der Vereniging Fabrieken van Hang- en Sluitwerk (VHS) und Allgemeine Lieferbedingungen der Vereniging Fabrikanten IJzerwaren en Gereedschappen (IJG).



EDITION 2017 Hermeta is in the possession of all exclusive rights regarding design, construction and presentation of the in this catalogue portrayed articles. Entirely or partial use is only permitted after granted permission in writing by Hermeta Metaalwaren bv in Asperen, Holland.

Pictures, dimensions and workmanship as shown in this catalogue are not binding; publication occurs with reservation.

All deliveries and transactions are according to the general delivery terms of Vereniging Fabrieken van Hang- en Sluitwerk (VHS) and the general delivery terms of Vereniging Fabrikanten IJzerwaren en Gereedschappen (IJG).



EDITION 2017 Hermeta est propriétaire exclusif des droits concernant les formes, les fabrications et les photographies publiées dans ce catalogue. L'utilisation partielle ou complète des photos ne pourra être effectuée sans un accord préalable et écrit de la société Hermeta Metaalwaren bv située à Asperen, Pays-Bas.

Les photographies et dimensions indiquées dans ce catalogue ne sont pas contractuelles.

Les conditions de livraison et de paiement se réfèrent aux conditions générales de vente de Vereniging Fabrieken van Hang- en Sluitwerk (VHS) et aux conditions générales de livraison de Vereniging Fabrikanten Uzerwaren en Gereedschappen (IJG).

Hermeta Metaalwaren bv

P.O. Box 1017,
4147 ZG Asperen
1e Industrieweg 1,
4147 CR Asperen The Netherlands

phone: +31 (0) 345 - 63 48 88

fax: +31 (0) 345 - 63 48 77

e-mail: metaalwaren@hermeta.nl

internet: www.hermeta.nl



green



Hermeta